

VIBIA

Plusminus

Design by Diez Office

Darklight

Assembly instructions / Instrucciones de montaje / Montageanleitung
Istruzioni di montaggio / Instructions de montage



Caution

Before assembling and installing this product, carefully read the following:

- Switch off the mains before installing the lamp.
- This lamp is for indoor use only, excluding bathrooms or any type of humid surface.
- We recommend reading the manual before installing the lamp. Keep this instructions for future reference.
- Do not disassemble, modify or try to repair this fitting. In order to get technical assistance contact VIBIA.com/support. Any change or modification to the light fitting can null the manufacturer's guarantee.
- All electronic products and batteries must be taken to separate waste collection points at the end of their working lives, they must not be disposed of in normal household waste. It is the responsibility of the user to dispose of the equipment using a designated collection point or service for separate recycling of waste electrical and electronic equipment (WEEE) and batteries according to local laws.
- Use these gloves to touch the lamp during the installation to avoid smudges and dirt on its surface.

Precaución

Antes de proceder al montaje e instalación de esta luminaria, leer detenidamente las siguientes consideraciones:

- Desconectar el suministro eléctrico antes de proceder a la instalación de la luminaria.
- Esta luminaria es apta únicamente para su uso en interior, excepto en baños o cualquier tipo de superficie húmeda.
- Recomendamos leer el manual antes de iniciar la instalación de la luminaria. Guardar estas instrucciones para futuras consultas.
- No desmonte, modifique, ni intente reparar la luminaria. Para recibir asistencia técnica, pongase en contacto con VIBIA.com/support. Cualquier cambio o modificación en la luminaria puede anular la garantía del fabricante.
- Todos los productos electrónicos y las baterías deben llevarse a puntos de recolección de residuos separados cuando finalicen sus ciclos de vida, no se deben desechar en la cadena normal de residuos con la basura doméstica. Es responsabilidad del usuario desechar los dispositivos en un punto o servicio de recolección designado para el reciclaje separado de residuos de aparatos eléctricos y electrónicos (WEEE), así como las baterías, de conformidad con las leyes locales.
- Utilice estos guantes para manipular la luminaria durante el montaje y evitar un posible trasvase de suciedad de sus manos.

Vorsicht

Bevor Sie mit der Montage dieser Leuchte beginnen, sollten Sie die folgenden Hinweise in aller Ruhe lesen und berücksichtigen:

- Schalten Sie vor dem elektrischen Anschluss den Strom ab.
- Diese Leuchte ist ausschliesslich für den Gebrauch im Innenbereich vorgesehen, ausser Bädern oder anderen Feuchträumen.
- Wir empfehlen vor Montagebeginn die Anleitung zu lesen. Bewahren Sie die Anleitung für etwaige zukünftige Fragen auf.
- Die Leuchte nicht auseinanderbauen, baulich ändern oder reparieren. Für technische Hilfe VIBIA.com/support kontaktieren. Eigenmächtig vorgenommene Änderungen an der Leuchte führen zu einem Verlust der Garantie.
- Alle elektronischen Produkte und Batterien am Ende Ihrer Lebensdauer getrennt entsorgt werden müssen, sie dürfen nicht über den normalen Fluss des Haushaltsmülls entsorgt werden. Es unterliegt der Verantwortlichkeit des Benutzers, die Ausrüstung unter Verwendung einer ausgewiesenen Sammelstelle oder eines Dienstes für getrenntes Recycling von elektrischen oder elektronischen Geräten und Batterien entsprechend der Gesetze vor Ort zu entsorgen (WEEE = Waste of Electrical and Electronic Equipment = Elektro - und Elektronikgeräte - Abfall).
- Benutzen Sie diese Handschuhe während der Montage, um keinen Schmutz der Hände auf die Leuchte zu übertragen.

Attention

Prima di procedere al montaggio e all'installazione di questo apparecchio, leggere attentamente le seguenti considerazioni:

- Scollegare l'alimentazione prima di procedere all'installazione dell'apparecchio.
- Questo apparecchio è adatto solo per uso interno, ad eccezione dei bagni o di qualsiasi tipo di superficie bagnata.
- Si consiglia di leggere il manuale prima di iniziare l'installazione dell'apparecchio. Salva queste istruzioni per future consultazioni.
- Non smontare, modificare né cercare di riparare la lampada. Per richiedere assistenza tecnica, mettersi in contatto con VIBIA.com/support. Qualsiasi cambiamento o modifica alla lampada può annullare la garanzia del fabbricante.
- Tutti i prodotti elettronici e le batterie devono essere separate in punti di raccolta dei rifiuti una volta terminato l'utilizzo, non devono essere smaltiti nel normale flusso dei rifiuti insieme ai rifiuti domestici. È responsabilità dell'utente smaltire l'apparecchiatura utilizzando un punto di raccolta o un servizio per il riciclo di rifiuti di apparecchiature elettroniche (RAEE) e batterie secondo le leggi vigenti.
- Indossare i guanti inclusi nella confezione per maneggiare la lampada durante il montaggio ed evitare di contaminare la superficie.

Attenzione

Avant de procéder à l'assemblage et à l'installation de ce luminaire, lisez attentivement les considérations suivantes:

- Débranchez l'alimentation avant de procéder à l'installation du luminaire.
- Ce luminaire ne convient que pour une utilisation en intérieur, sauf dans les salles de bains ou tout type de surface humide.
- Nous vous recommandons de lire le manuel avant de commencer l'installation du luminaire. Sauvegardez ces instructions pour futures consultations.
- Ne démontez pas le luminaire, ne le modifiez pas et n'essayez pas de le réparer. Pour bénéficier d'une assistance technique, contactez VIBIA.com/support. Toute altération ou modification du luminaire peut annuler la garantie du fabricant.
- Tous les produits électroniques et toutes les batteries doivent être apportés à des points de collecte distincts de ceux des ordures ménagères normales lorsqu'ils arrivent en fin de vie. Il incombe à l'utilisateur de se débarrasser de l'équipement dans un point de collecte ou auprès d'un service spécifiquement désigné pour le recyclage des déchets électriques et des équipements électroniques (DEEE) ainsi que des batteries, dans le respect de la législation locale.
- Lors du montage, manipulez ce luminaire à l'aide des gants fournis pour éviter toute trace de doigts.





Step 1
Product Spec Sheet



Step 2
Supplied Materials



Step 3
Electrical Connection









Step 4
Adjustments & Maintenance



Step 1/4 Product Spec Sheet

Technical specifications / Especificaciones técnicas / Technische Daten
Specifiche tecniche / Caractéristiques techniques







6260

Net Weight / Peso Neto / Netto-Gewicht / Peso netto / Poids net 0,50 kg. / 1.10 lbs  1 x LED 24V 10,3W      

6265

Net Weight / Peso Neto / Netto-Gewicht / Peso netto / Poids net 1,00 kg. / 2.20 lbs  1 x LED 24V 20,6W      



6270

Net Weight / Peso Neto / Netto-Gewicht / Peso netto / Poids net 1,50 kg. / 3.30 lbs  1 x LED 24V 41,3W      







6275

Net Weight / Peso Neto / Netto-Gewicht / Peso netto / Poids net 0,50 kg. / 1.10 lbs  1 x LED 24V 10,3W      

6280

Net Weight / Peso Neto / Netto-Gewicht / Peso netto / Poids net 1,00 kg. / 2.20 lbs  1 x LED 24V 20,6W      

6285

Net Weight / Peso Neto / Netto-Gewicht / Peso netto / Poids net 1,50 kg. / 3.30 lbs  1 x LED 24V 41,3W      



Class III. Electrical product with low voltage safety connection.

Clase III. Aparato alimentado a muy baja tensión de seguridad.

Klasse III: Apparat mit Schutz gegen elektrischen Stromschlag durch Anwendung der Schutzkleinspannung. Ohne Schutzleiter.

Classe III. Apparecchio alimentato a tensione molto bassa di sicurezza.

Classe III. Appareil avec alimentation à très basse tension de sécurité.

IP20

Product protected against solid object as big as or bigger than 12 mm. No protection against water.

Producto protegido contra la penetración de cuerpos sólidos de tamaño igual o superior a 12mm. Sin protección al agua.

Produkt ist geschützt gegen das Eindringen von Fremdkörpern >12mm. Kein Schutz gegen Eindringen von Wasser.

Prodotto protetto contro la penetrazione di corpi solidi di dimensioni pari o superiori a 12 mm. Non protetto dall'acqua.

Produit protégé contre les intrusions de corps solides de taille égale ou supérieure à 12 mm. Non protégé contre l'eau.

Dry Location

This lamp is for indoor use only, excluding bathrooms or any type of damp surface.

Esta lámpara es solo para uso en interiores, excluyendo baños o cualquier tipo de superficie húmeda.

Diese Lampe ist nur für die Verwendung in Innenräumen bestimmt, ausgenommen Badezimmer oder jede Art von feuchten Oberflächen.

Questa lampada è solo per uso interno, esclusi i bagni o qualsiasi tipo di superficie umida.

Cette lampe est exclusivement destinée à une utilisation en intérieur, à l'exclusion des salles de bain et de toute surface humide.



Step 2/4

Supplied Materials

Supplied material / Material suministrado / Geliefertes Material
Materiale incluso / Matériel fourni

6260 6265 6270 6275 6280 6285

1. Lighting fixture / Estructura luminaria / Leuchtenstruktur /
Struttura lampada / Structure du luminaire

1 un.

1 un.

1 un.

1 un.

1 un.

1 un.

DARKLIGHT - Linear low UGR High Confort

6260



268 mm / 10 1/2"

6265



525 mm / 20 3/4"

6270

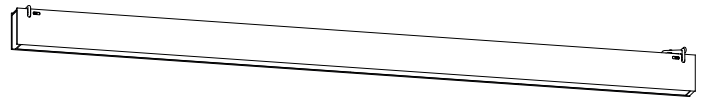

1037 mm / 40 3/4"

DARKLIGHT - Linear low UGR High Efficiency

6275



268 mm / 10 1/2"

6280

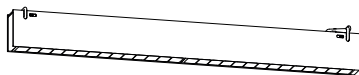

525 mm / 20 3/4"

6285

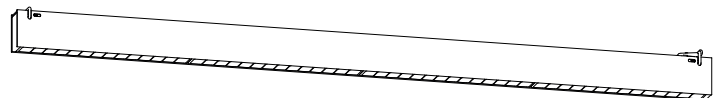

1037 mm / 40 3/4"



Step 3/4

Electrical Connection

Connect luminaire / Conectar luminaria / Leuchte verbinden
Collegare l'apparecchio d'illuminazione / Connector le luminaire

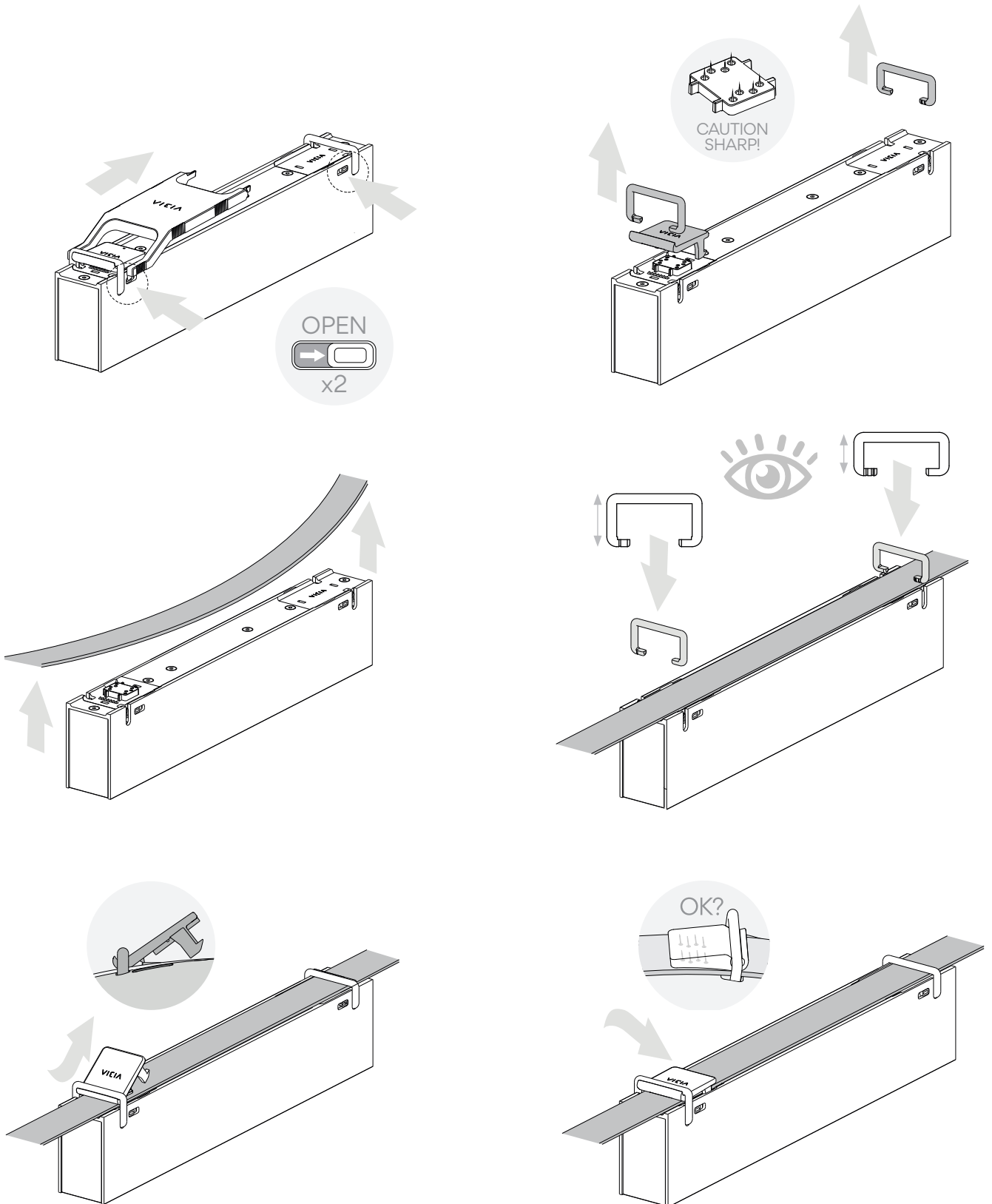



Step 4/4

Adjustments & Maintenance

Adjust belt tension / Ajustar la tensión de la cinta / Riemenspannung einstellen
Regolare la tensione della cinghia / Réglage de la tension du ruban

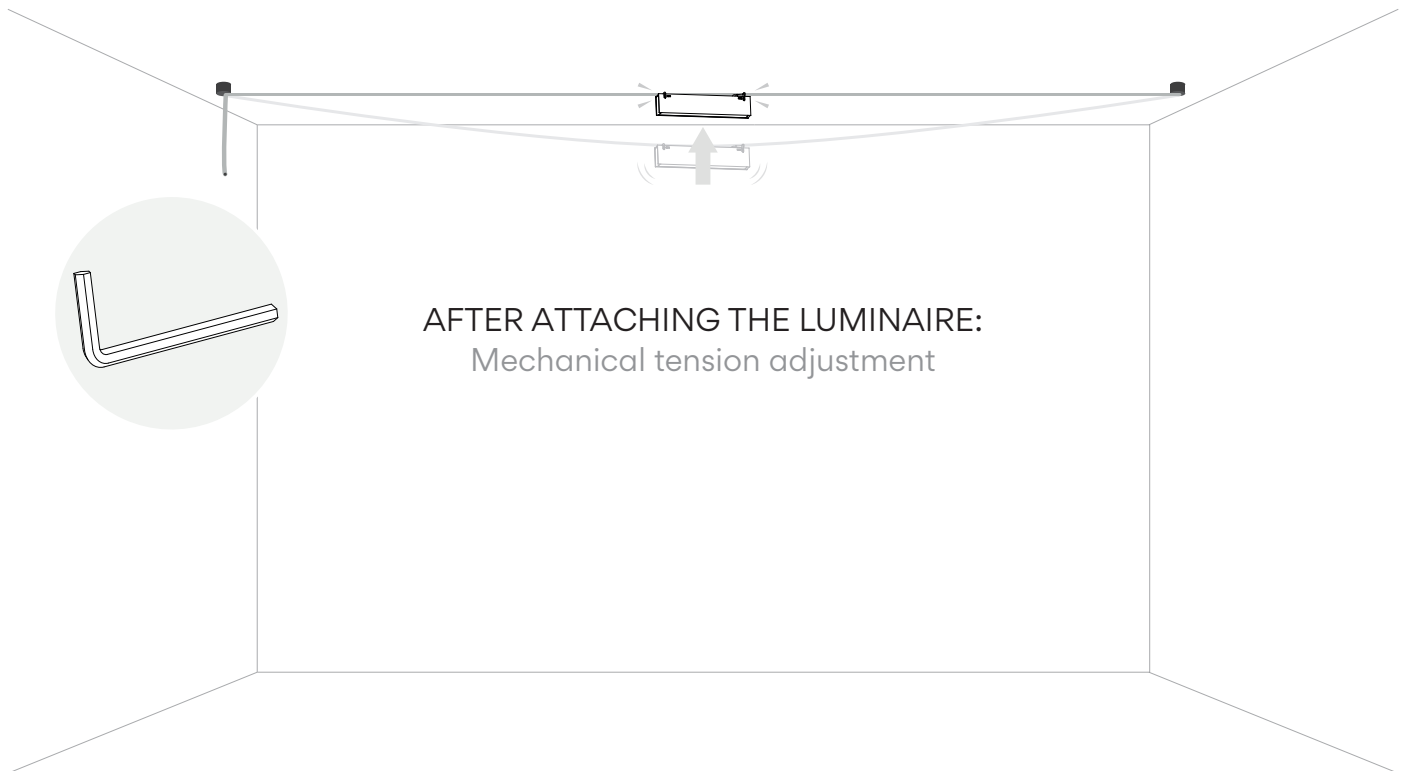
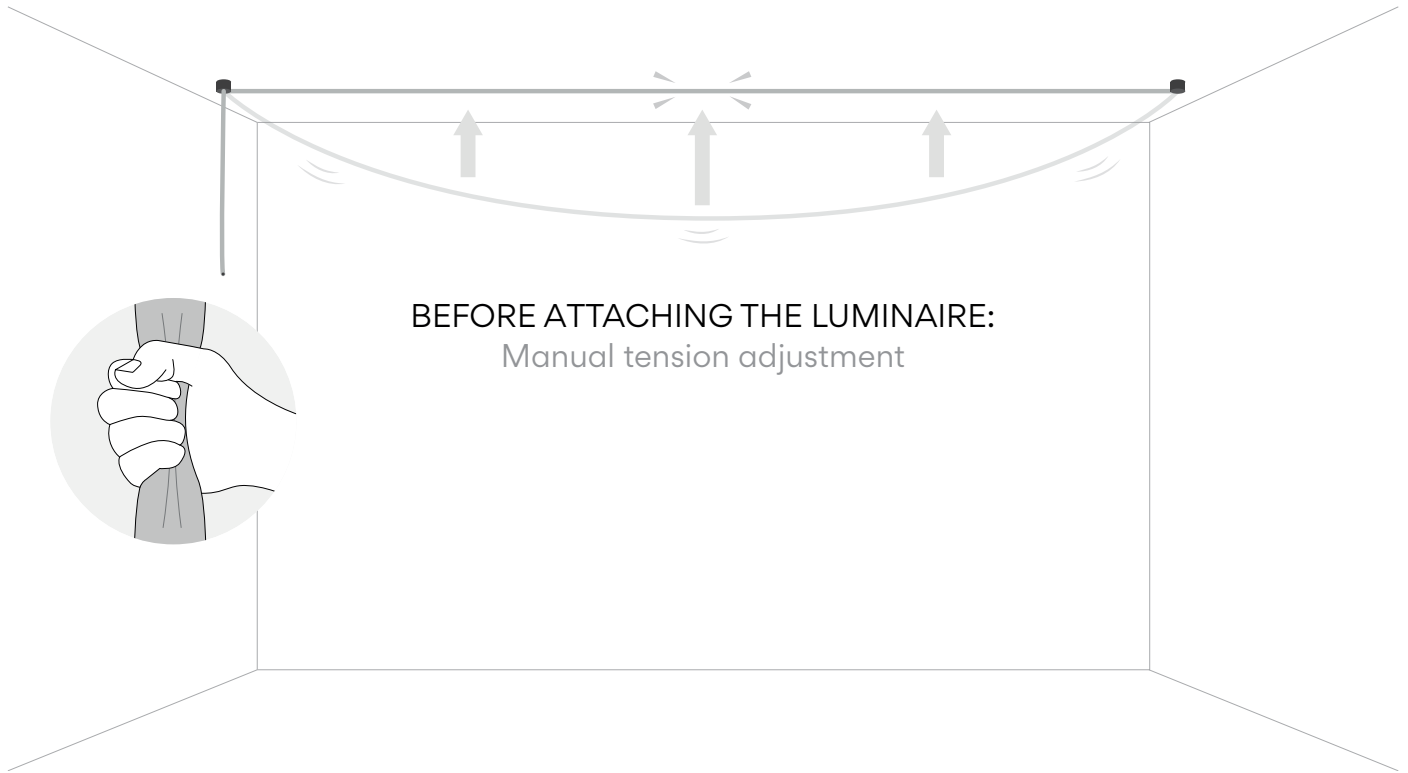

Maintenance

Use a slightly-wet cotton cloth for cleaning.

In case of malfunction or damage, please contact the retailer who sold the lamp.

Mantenimiento

Para limpiar la luminaria, usar un paño de algodón ligeramente humedecido en agua.

En caso de avería o incidente con la luminaria, contactar directamente con el establecimiento en que se adquirió.

Instandhaltung

Zur Reinigung der Leuchte nutzen Sie einen leicht angefeuchteten Baumwoll-Lappen.

Im Falle des Ausfalls oder einer Fehlfunktion der Leuchte setzen Sie sich direkt mit dem Unternehmen in Verbindung bei dem Sie die Leuchte bezogen haben.

Manutenzione

Per la pulizia della lampada, usare un panno di cotone leggermente inumidito con acqua.

In caso di guasto o incidente con la lampada, rivolgersi direttamente al rivenditore da cui è stata acquistata.

Entretien

Pour nettoyer le luminaire, utilisez un chiffon en coton légèrement humidifié d'eau.

En cas d'incident ou de défaillance du luminaire, contactez directement l'établissement où vous l'avez acheté.

Only for the State of California:

-  **WARNING:** The products distributed by Vibia Inc. may contain chemicals known to the State of California to cause cancer and birth defects or other reproductive harms. For more information go to www.P65Warnings.ca.gov

-  **ATTENTION :** Les produits distribués par Vibia Inc. peuvent contenir des substances chimiques reconnues par l'État de Californie comme étant cancérigènes, pouvant provoquer des malformations de naissance ou nuire à la reproduction. Pour plus de renseignements veuillez consulter www.P65Warnings.ca.gov

Vibia Lighting, S.L.U.

Spain & Portugal T. +34 934 796 970

International T. +34 934 796 971

US & Canada T. +1 609 732 417 1700

vibialighting@vibialighting.com

www.vibia.com

VIBIA