

kreon installation manual

technics & dimensions

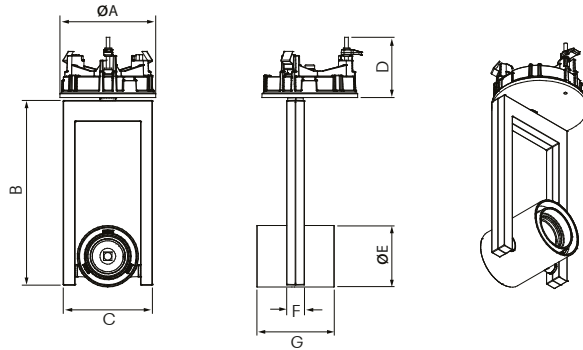

name	reference	current	ØA	B	C	D	ØE	F	G
diapason 40 base	KR90661x-xxx-xx-xx	1050mA	80.5	130	45	50.1	51	15	65
diapason 80 base	KR91661x-xxx-xx-xx	500mA	80.5	155	75	50.1	95	15	65
diapason 120 base	KR92661x-xxx-xx-xx	700mA	80.5	180	130	50.1	33	15	65

Please make sure the main voltage is disconnected before proceeding! ⚡

1. installation

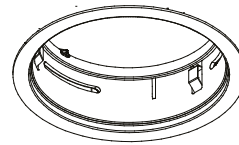

Install installation kit of choice

Installation kit with trim KR71702x
Consult installation manual KR8166002147

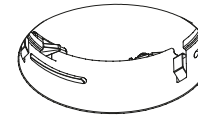

Installation kit without trim KR717104
Consult installation manual KR8170001755

2. installation

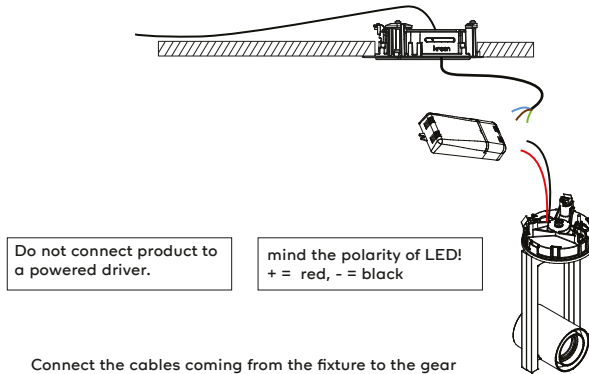

Do not connect product to a powered driver.

mind the polarity of LED!
+ = red, - = black

Connect the cables coming from the fixture to the gear
Connect the mains voltage to the gear

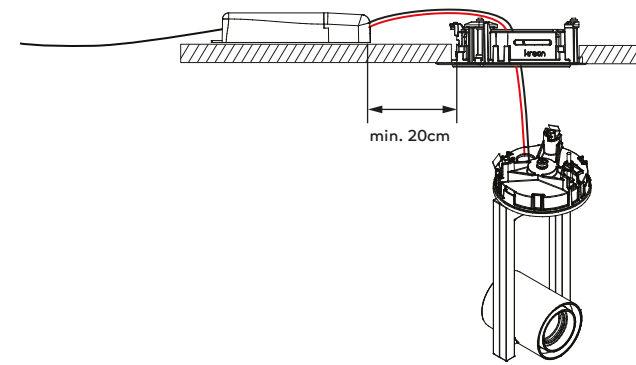

min. 20cm

Push the gear through the plasterkit onto the ceiling

3. installation

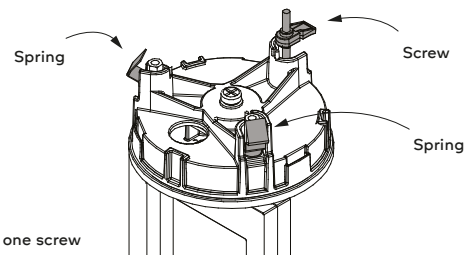

The installation disk has two springs and one screw

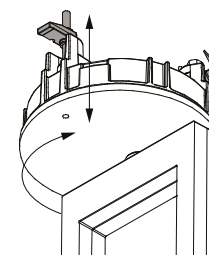

Rotate the cover disc until it's blocked and check if the hole matches the screw

kreon installation manual

4. installation

Insert the Diapason in the installation kit
Match the details of the black plastic installation part with the springs of the installation kit

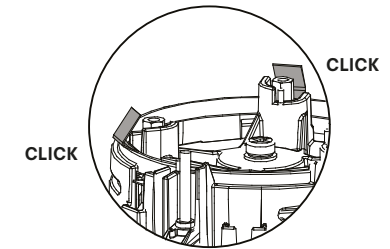
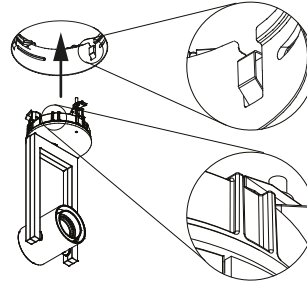

Push until the springs click over the edge of the installation kit

5. installation

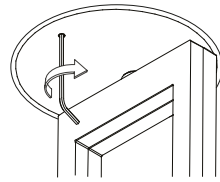

Fix the Diapason by turning the screw with the hex key

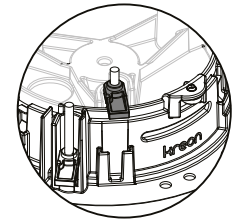
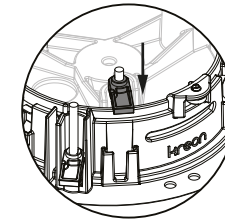
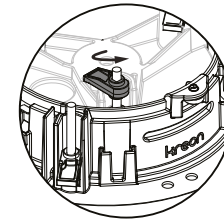
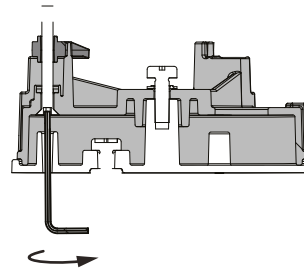

The screw will tighten on the edge of the installation kit

6. installation

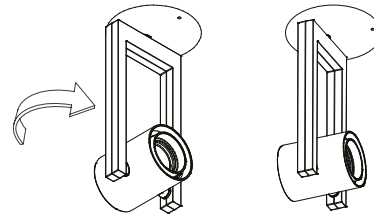

The diapason can rotate max. 355°

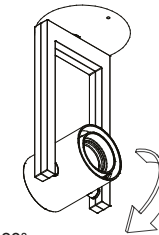

The light can be inclined max. 90°

7. Pictures

