

kreon installation manual

technics & dimensions

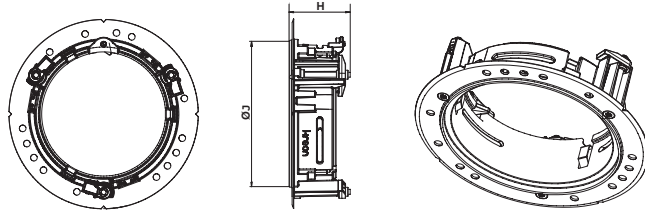

name	reference	Ø3xH
Aplis in-line 80 plasterkit no shadow gap	KR717104	80x36,8
Aplis in-line 80 plasterkit shadow gap	KR717108	86x36,8
Aplis in-line 40 plasterkit no shadow gap	KR707104	40x27
Aplis in-line 40 plasterkit deep recessed	KR707704	40x51

technics & dimensions

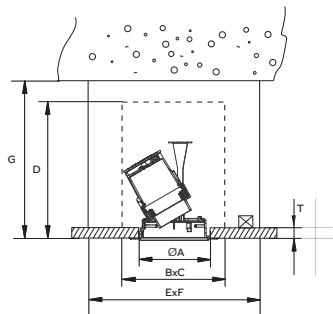

name	reference	lamp type	ØA	BxC	D _{min}	ExF	G _{min}	T _{min} -T _{max}
Plasterkit aplis in-line 80	KR717104	QR-CBC51	102	170x170	130	320x320	200	9-26
Plasterkit aplis in-line 80 shadow gap	KR717108	LED dir.	102	170x170	140	300x300	157	9-26
		LED dir.	102	Ø95	115	344x344	120	9-26
		Fixed, WW	102	200x200	100	260x260	100	9-26
		Audio	102	150x150	130	200x200	130	9-26
		Dir. / LED MR16	102	191x191	110	350x350	110	9-26
		Dir. / LED PAR16	102	176x176	130	330x330	130	9-26
		Diapason 40/80/120bas	102	110x110	70*	110x110	70*	9-26
		Holon 80 directional rec.	102	110x110	60**	110x110	x***	9-26
		ATO 80 in-line	102	Ø150	110	300x300	157	9-26
		Oran in-line	102	110x110	80	300x300	100	9-26
Plasterkit aplis in-line 40	KR707104	LED dir, fixed, WW	63	110x110	80	110x110	80	9-14
Plasterkit aplis in-line 40 deep recessed	KR707704	fixed	63	110x110	104	110x110	104	9-14

ExFxG: min dimension for cooling, gear inclusive
 BxCxD: min dimension for rotation
 (can be applied with non combustable matter, gear exclusive)

* in case of standard driver(KR772024/ KR772022/KR772122) which needs to be pushed through the plasterkit in case of driver placed at distance (doesn't need to be pushed trough the plasterkit) D/Gmin = 60 in case of a different driver, the installation depth D/Gmin = length of driver + 30mm

** installation depth D in case the driver is placed at a distance, so doesn't need to be pushed through the plasterkit installation depth G is in case the driver has to be pushed through the plasterkit in order to be close to the fixture mind that the drives dimensions WxH cannot exceed 79x29,5mm

*** the length of the driver determines G as it has to be pushed perpendicular through the plasterkit depth = length of driver + 30mm

kreon installation manual

installation

Put the plasterkit through the hole.

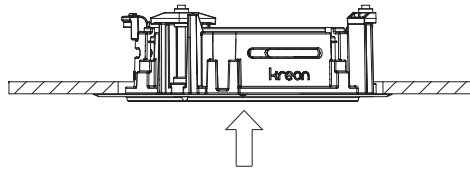

Fix the plasterkit with the screws.

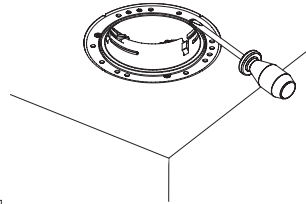

Assembling torque max 20 cN.m.

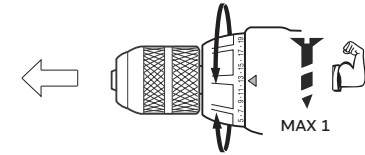

Please make sure that sticker is removed before proceeding

installation

Assembling principle

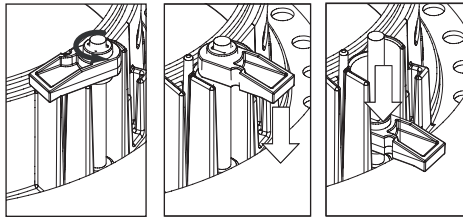

Fill around perimeter of plasterkit using suitable filler and plaster to hide screws and plasterkit

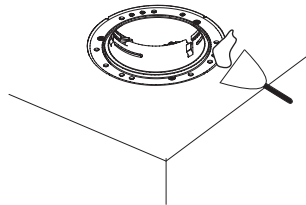

Minimum filler distance, spread out until zero.

