

Occhio

Mito sfera

Montageanleitung
Mounting instructions

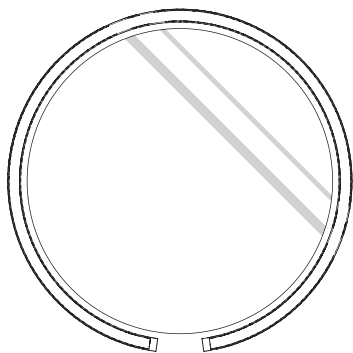

Inhalt / Contents

Sicherheitshinweise	04	Safety precautions	05
Produktbeschreibung	06	Product description	07
Schritt 1		Step 1	
Steuerung	09	Control	09
Mito set box (standard)	11	Mito set box (standard)	11
Mito »air« box (optional)	21	Mito »air« box (optional)	21
Schritt 2		Step 2	
Montage	29	Mounting	29
Montage / optional		Montage / optional	
Seiteneinspeisung	38	sideways inlet	38
Steuerung mit der Occhio air App (optional)	45	Control using the Occhio air app (optional)	45
Steuerung mit dem Occhio air controller (optional)	53	Control using the Occhio air controller (optional)	53
Anhang	57	Appendix	57
Pflegehinweise	58	Care instructions	58
Info & Kontakt	59	Information & contact	59
Technische Daten	60	Technical data	61

Sicherheitshinweise

Lesen Sie die Montage-/Gebrauchsanweisung sorgfältig durch, bevor Sie die Leuchte installieren. Beachten Sie die Sicherheitshinweise in dieser Anleitung genau und bewahren Sie die Anleitung auf.



Dieses Zeichen macht Sie auf eine gefährliche Situation aufmerksam, die eine schwere Verletzung oder den Tod nach sich ziehen kann, wenn sie nicht beachtet wird. Es macht Sie zudem auf mögliche Sachschäden und andere wichtige Informationen in Verbindung mit diesem Produkt aufmerksam.



Die Montage von Elektrokomponenten darf nur von qualifiziertem Fachpersonal durchgeführt werden. Reparaturarbeiten dürfen nur von autorisiertem Fachpersonal oder dem Hersteller durchgeführt werden. Vor allen Arbeiten an der Leuchte (Installation, Reinigung etc.) diese unbedingt vom Stromnetz trennen.



Dieses Zeichen macht Sie auf Situationen aufmerksam, bei denen Sie direkt in das Licht der LED blicken könnten. Dies kann zu Nachbildern und bei längerer Dauer zu Schädigungen der Augen führen.



Sicherheitsabstand zu brennbaren Objekten einhalten: 20 cm!



Dieses Zeichen macht Sie auf heiße Oberflächen aufmerksam, deren Berührung Verbrennungen zur Folge haben können.

Achtung: Die Oberfläche der Leuchte kann nach längerer Betriebsdauer heiß sein! Vor allen Arbeiten an der Leuchte (Montage usw.), Leuchte immer ausschalten und mindestens 30 Minuten abkühlen lassen. Nur zur Installation außerhalb des Handbereichs vorgesehen.

Safety precautions

Read through the mounting/ use instructions carefully before installing the luminaire. Follow the safety precautions in these instructions closely and keep the instructions in a safe place.



This symbol warns you of a dangerous situation which could lead to serious injury or even death if the instructions are not observed. It also draws your attention to possible material damage and provides other important information in connection with this product.



The assembly and installation of electrical components must be carried out only by qualified personnel. Repairs must be carried out only by authorised, qualified personnel or the manufacturer. Before performing any work on the luminaire (installation, cleaning, etc.), it must be disconnected from the mains supply.



This symbol draws your attention to situations in which you could look directly into the light of the LED. This may cause an after-image effect and may result in damage to the eyes if you look at the light directly for prolonged periods.



Maintain the minimum safety distance from flammable materials: 20 cm.



This symbol warns you of hot surfaces, which could cause burns if touched.

Caution: When used for prolonged periods, the surface of the luminaire can become hot. Before performing any work on the luminaire (fitting the luminaire etc.), always switch the luminaire off and let it cool for at least 30 minutes. Only for installing in a position which is out of arm's reach.

Produktbeschreibung

Ringförmige LED Spiegel-Wandleuchte mit einseitigem Lichtaustritt und einem Durchmesser von 40 cm oder 60 cm. Die Lichtwirkung bietet blendfreies Licht für eine perfekte Ausleuchtung. Version mit integriertem Vorschaltgerät für Aufputzmontage, Anschluss an 230 V AC Netzspannung.

Steuerbar über »touchless control« (Gestensteuerung am head) oder Occhio air, alternativ dimmbar via Phasenabschnitt-dimmer*. Die Farbtemperatur ist stufenlos steuerbar via »touchless control« oder Occhio air von 2700–4000 K oder voreinstellbar (2700 / 3000 / 3500 / 4000 K).

* Liste kompatibler Dimmer: www.occhio.com/dim, Phasenabschnittdimmer und Occhio air sind nicht kombinierbar

Product description

Ring-shaped LED mirror-wall luminaire with single-sided light output, available in the following diameters: 40 cm or 60 cm. The lighting effect provides glare-free light for perfect illumination. This version features an integrated power supply unit for surface mounting and connects to 230 V AC mains voltage.

The luminaire can be controlled using »touchless control« (gesture control at the head) or Occhio air, or can be dimmed using a trailing-edge phase cut dimmer*. The color temperature is continuously adjustable between 2700–4000 K or can be preset (2700 / 3000 / 3500 / 4000 K) using »touchless control« or Occhio air.

* For a list of compatible dimmers, see www.occhio.com/dim_en, trailing-edge phasecut dimmer and Occhio air not combinable

Steuerung

Funktionen / Steuerungsmöglichkeiten der Leuchte einstellen.

Control

Set functions / control options of the luminaire.

Mito set box (standard)

Seite / page 11

Mito »air« box (optional)

Seite / page 21

Mito set box
(standard)

Mito set box (standard)

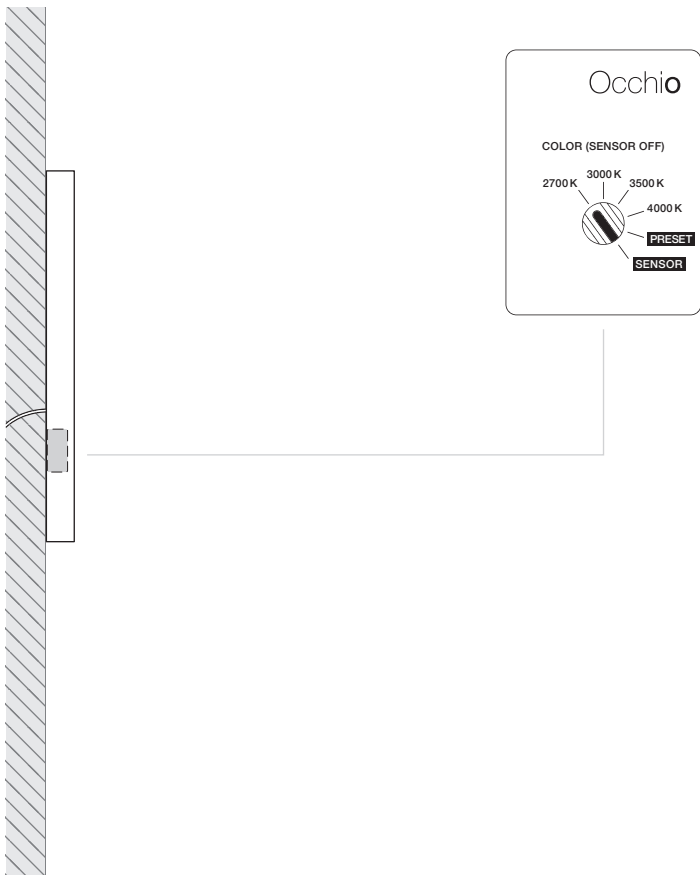



SENSOR = »touchless control« *

Gestensteuerung / gesture control (Seite / page 14)

- schalten / switching
- dimmen / dim
- color tune

PRESET = PRESET *

extern schalten / switch externally (Seite / page 16)

- Lichtintensität einstellbar (5 Stufen)
light intensity adjustable (5 stages)
- Farbtemperatur einstellbar (4 Stufen)
color temperature adjustable (4 stages)

COLOR (SENSOR OFF)

2700K 3000K 3500K 4000K = **color preset****

Farbtemperatur voreinstellbar, extern schalten und dimmen
color temperature pre-settable switch and dim externally
(Seite / page 18)

- extern schalten und dimmen
switch and dim externally

* **Nicht kombinierbar** mit einem externen
Phasenabschnittdimmer.

** **Kombinierbar** mit einem externen
Phasenabschnittdimmer.

* **Can not be combined** with an external
trailing-edge phasecut dimmer.

** **Can be combined** with an external
trailing-edge phasecut dimmer.

» touchless control «

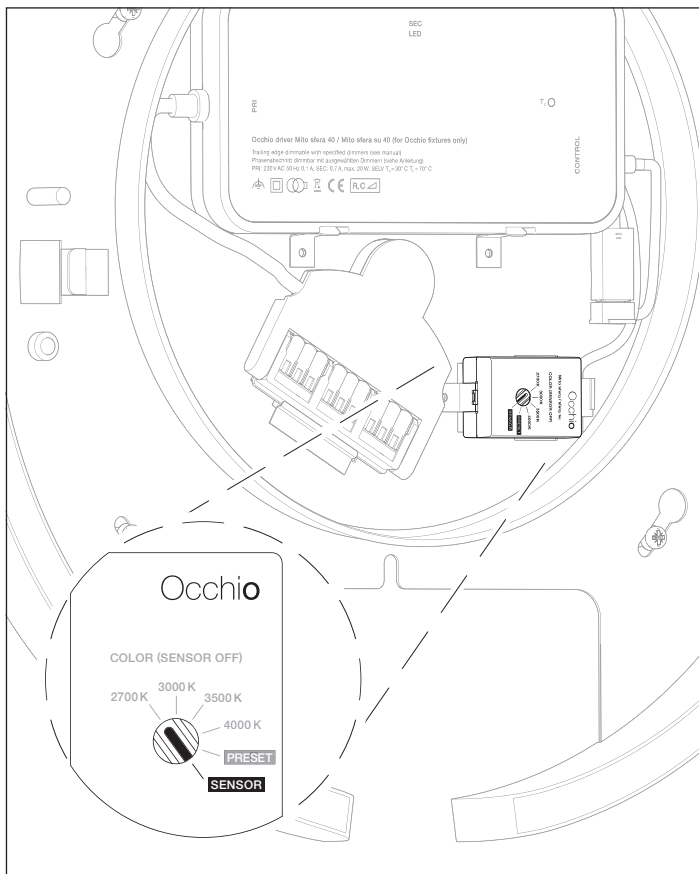

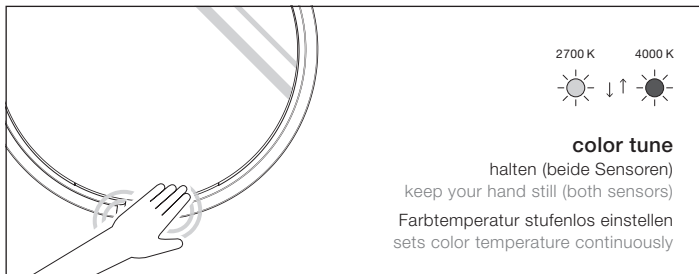
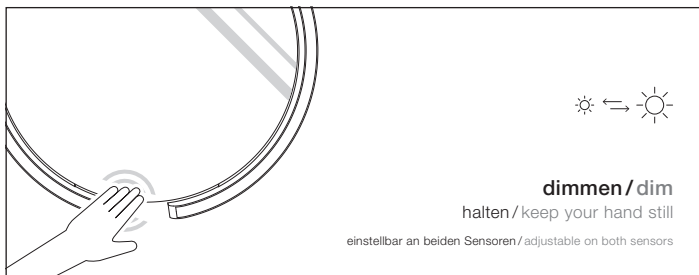
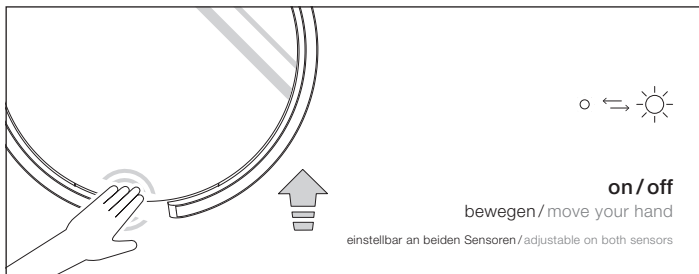

PRESET

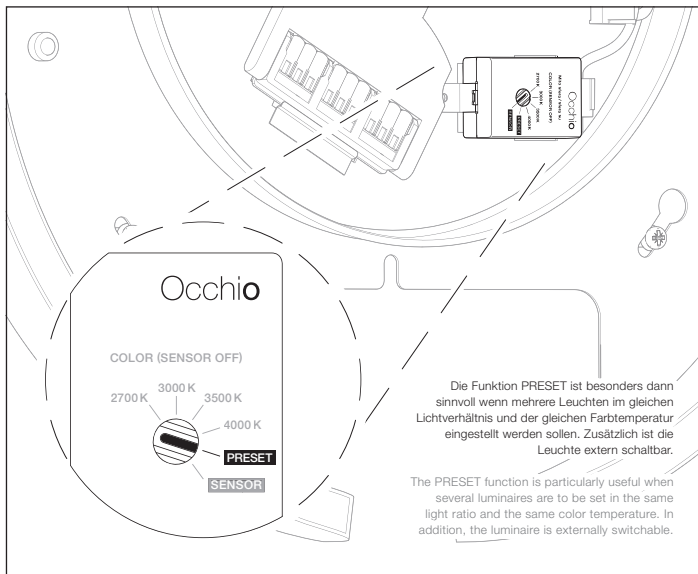

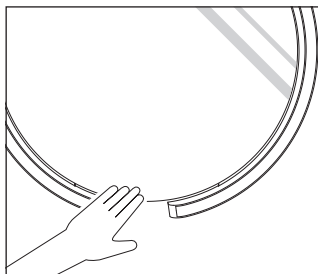

dimmen / dim

lange halten / keep your hand still for a time

Lichtverhältnis in 5 Stufen einstellen
sets the lighting conditions in 5 stages

einstellbar an beiden Sensoren / adjustable on both sensors

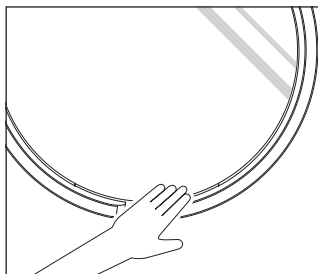

2700 K 3000 K 3500 K 4000 K



color tune

halten (beide Sensoren)

keep your hand still (both sensors)

Farbtemperatur in 4 Stufen einstellen
sets color temperature in 4 stages

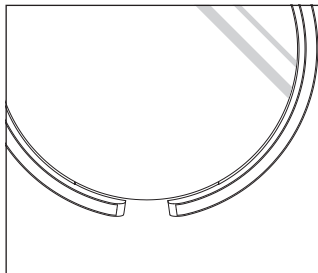

5 Min. warten oder
ausschalten, 10 Sek. warten, einschalten
wait for 5 min. or
switch off, wait 10 sec., switch on

Einstellung ist nun gespeichert
the setting is now saved

color preset (»touchless control« deaktiviert /
»touchless control« deactivated)

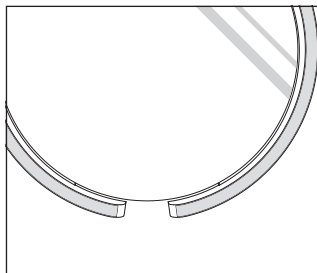
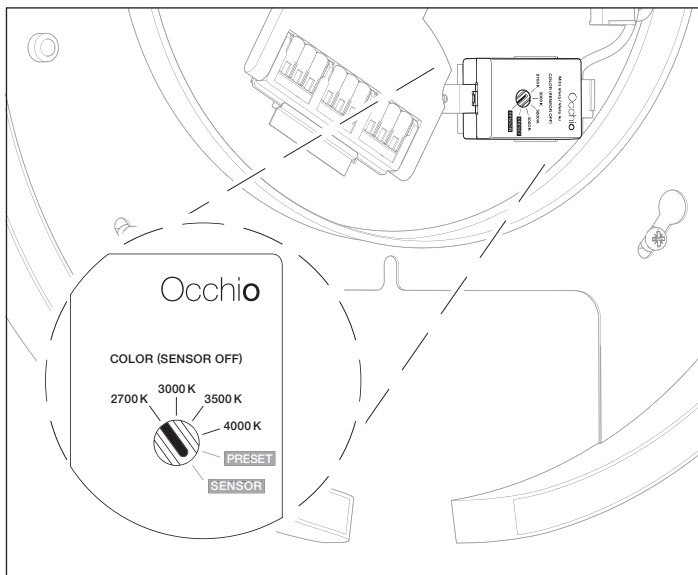

Farbtemperatur voreinstellbar
color temperature pre-settable
(2700 K, 3000 K, 3500 K, 4000 K)

»touchless control« **deaktiviert**
»touchless control« **deactivated**

phasenabschnitt dimmbar
trailing-edge phase cut dimmable



Mito »air« box
(optional)

Mito »air« box (optional)

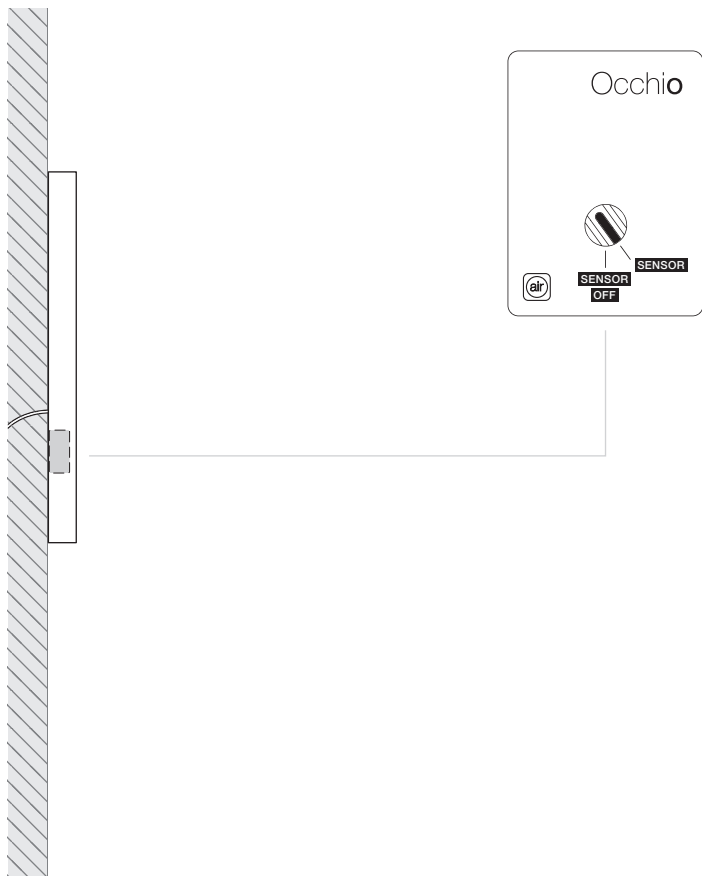



SENSOR = »touchless control« + »air«

Bluetooth- und Gestensteuerung / bluetooth and gesture control
(Seite / page 24)

- schalten / switching
- dimmen / dim
- color tune

SENSOR OFF = »air«

Bluetoothsteuerung / bluetooth control (Seite / page 26)

- schalten / switching
- dimmen / dim
- color tune

Nicht kombinierbar mit einem externen Phasenabschnittdimmer.

Can not be combined with an external trailing-edge phasecut dimmer.

» touchless control « + » air «

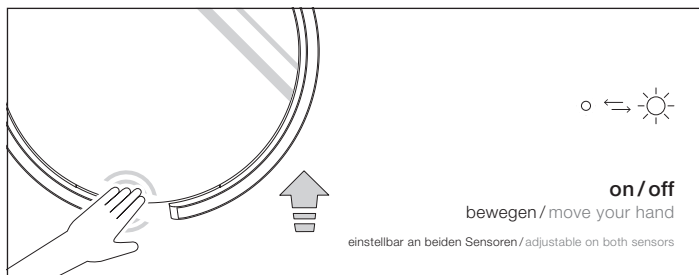
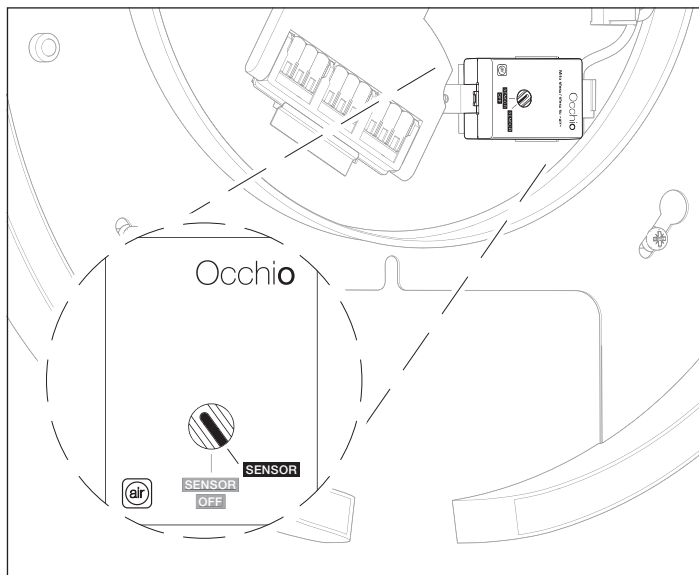

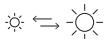
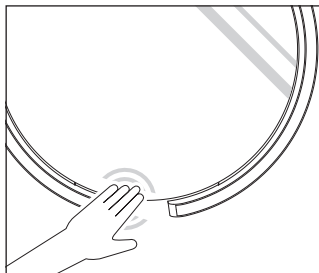

dimmen / dim

halten / keep your hand still

einstellbar an beiden Sensoren / adjustable on both sensors

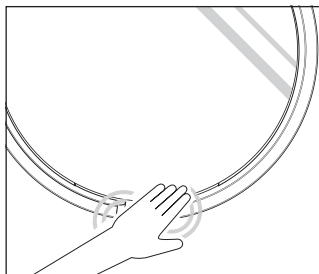

2700 K 4000 K

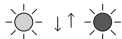

color tune

halten (beide Sensoren)

keep your hand still (both sensors)

Farbtemperatur stufenlos einstellen
sets color temperature continuously

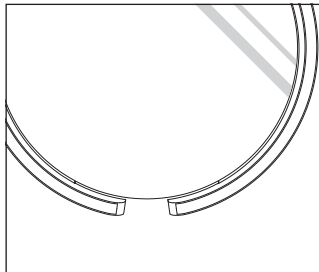

Steuerung via Occhio air, siehe Seite 45.

Control via Occhio air, see page 45.

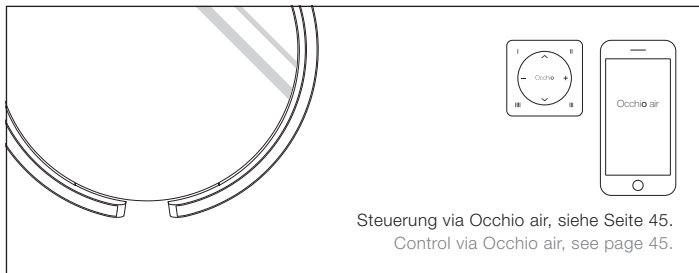
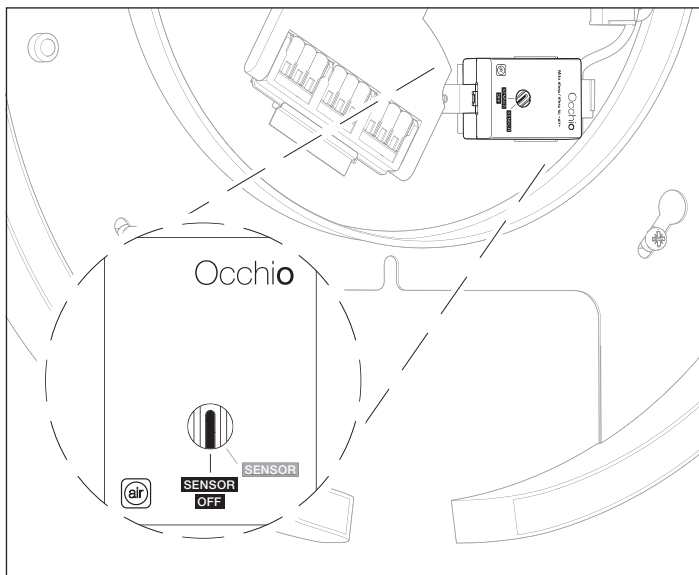

Steuerung via Occhio air, siehe Seite 45.
Control via Occhio air, see page 45.



Montage

Mounting

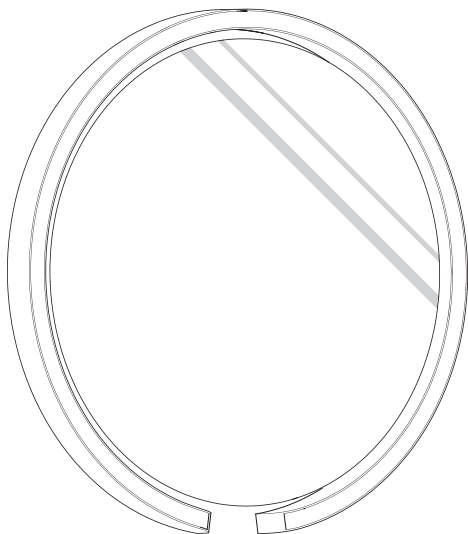

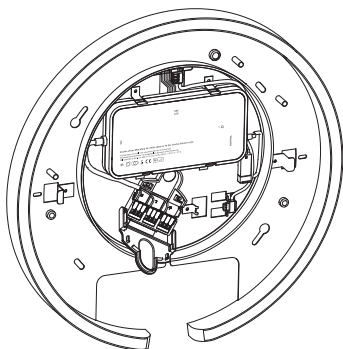

Mito sfera 40/60
(inkl. Occhio Treiber)
(incl. Occhio driver)



Mito sfera set box
(vormontiert / pre-installed)



Mito sfera »air« box

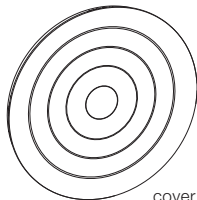

cover

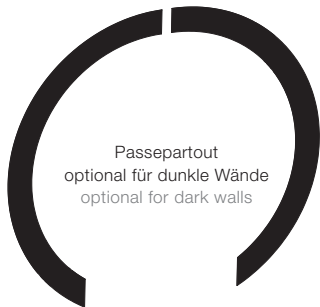

Passepartout
optional für dunkle Wände
optional for dark walls

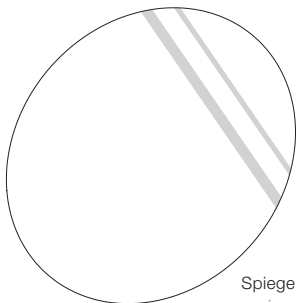

Spiegel
mirror



**Bohrschablone
benutzen!**

Use drilling
template!

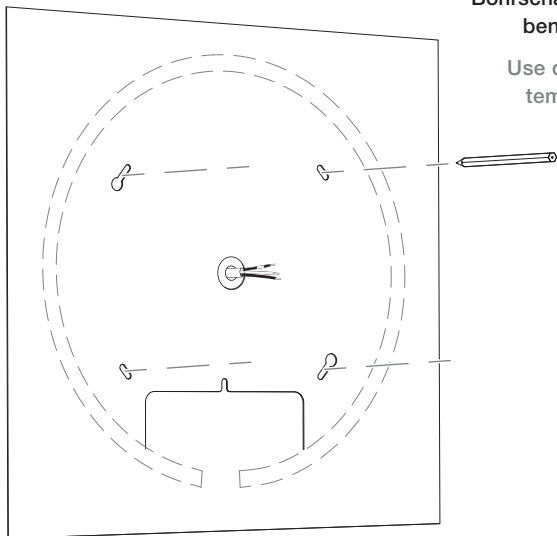

**Vor der Montage alle
stromführenden Leitungen
vom Stromnetz trennen!**



**Before mounting, disconnect
all currentcarrying lines from
the mains supply!**

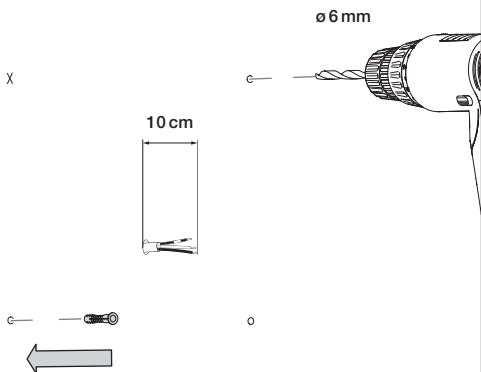

Achtung!
Auf den Verlauf von
Stromleitungen achten!



Caution!
Check the routing of the
power cables.

Montage / Mounting

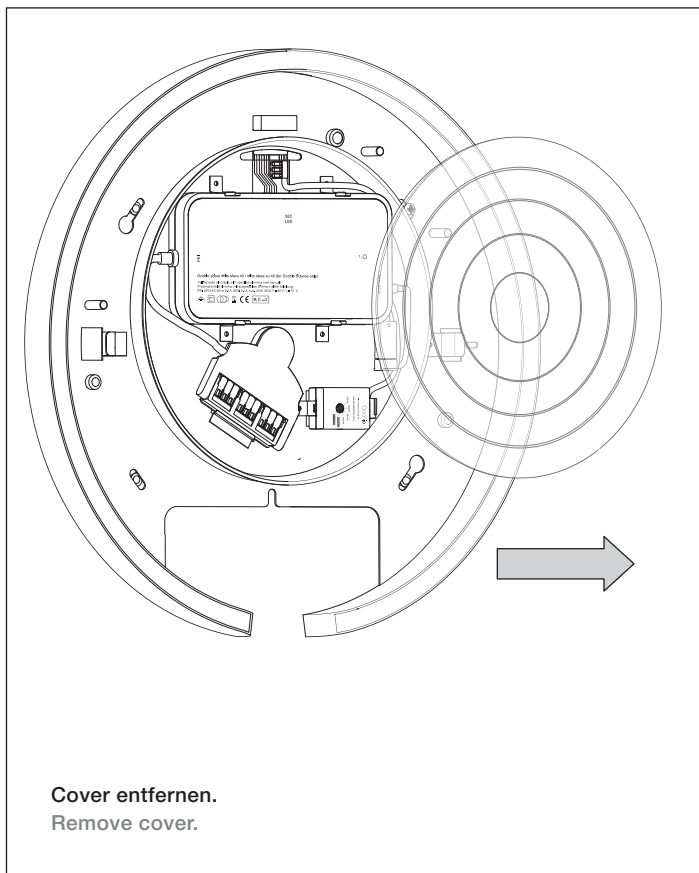



Ausrichtung beachten.
Note alignment.

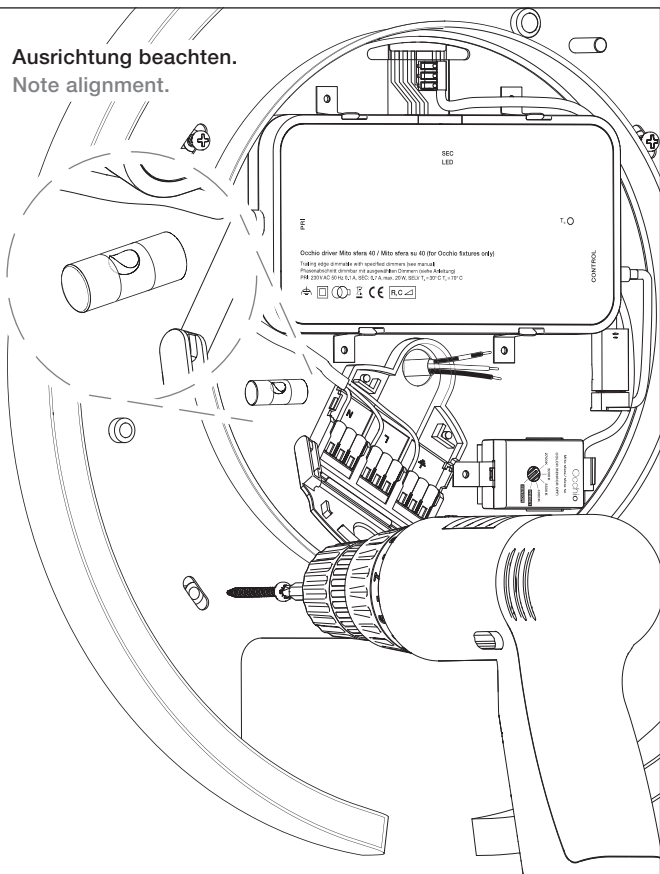

Montage / Mounting





Occhio driver Mito sfera 40 / Mito sfera su 40 (for Occhio fixtures only)

Trailing edge dimmable with specified dimmers (see manual)
Phasenabschnitt dimmbar mit ausgewählten Dimmern (siehe Anleitung)
PRI: 230 VAC 50 Hz 0,1 A, SEC: 0,7 A, max. 20 W, SELV T_a = 30° C T_c = 70° C



CONTROL

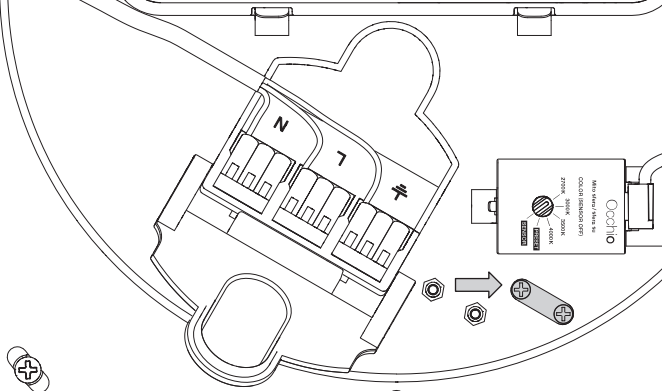

**Zugentlastung
lösen und Stopfen
entnehmen.**

**Loosen strain relief
and remove plug.**



Montage / optional Seiteneinspeisung Montage / optional sideways inlet

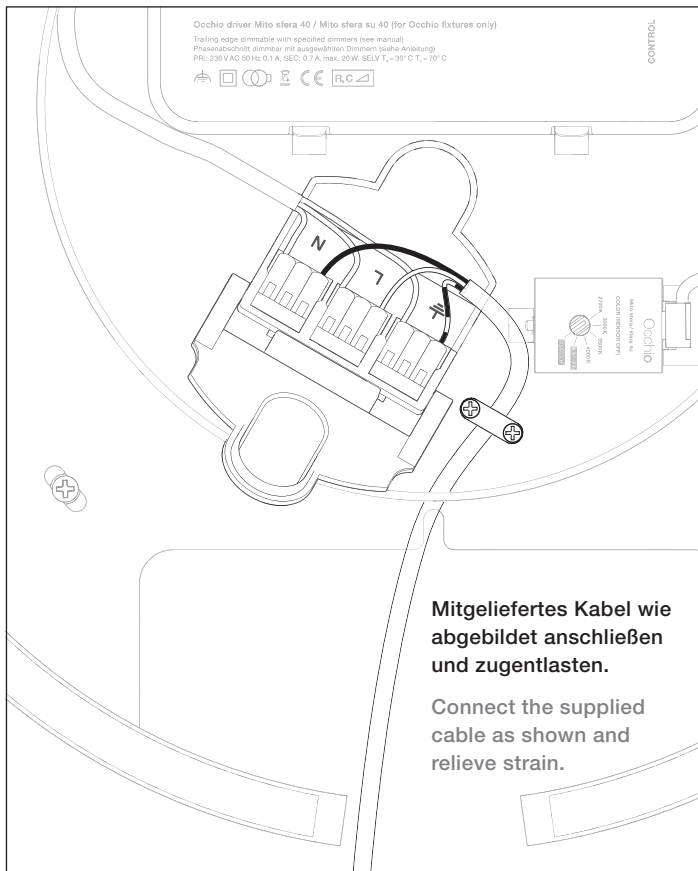

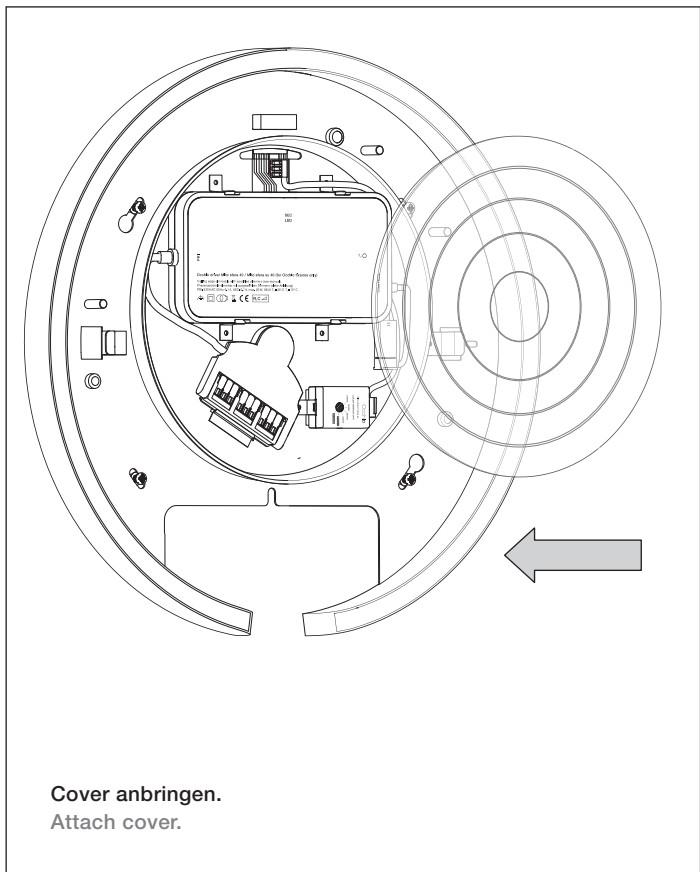

Cover anbringen.
Attach cover.

Montage / Mounting

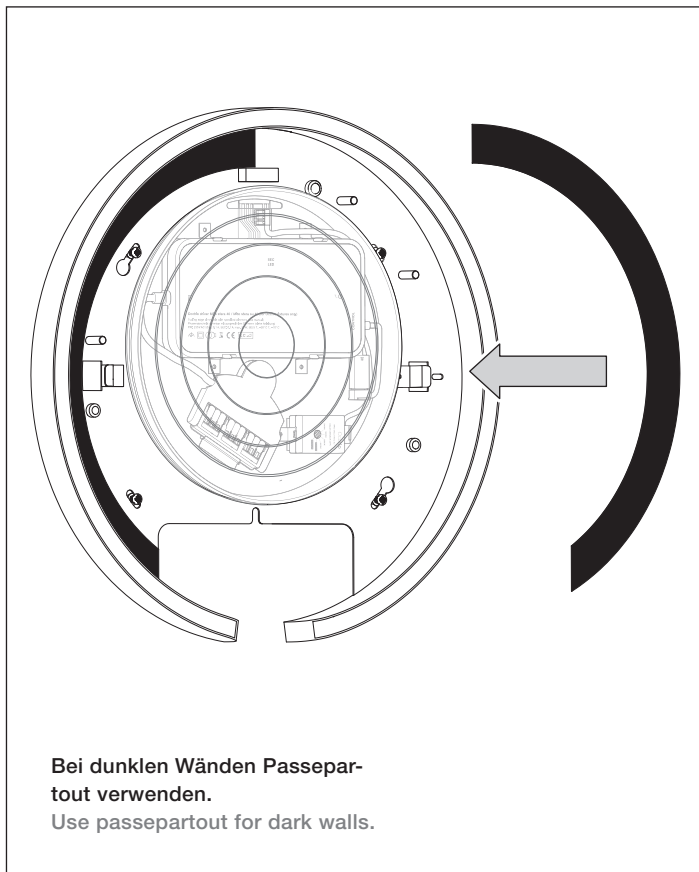

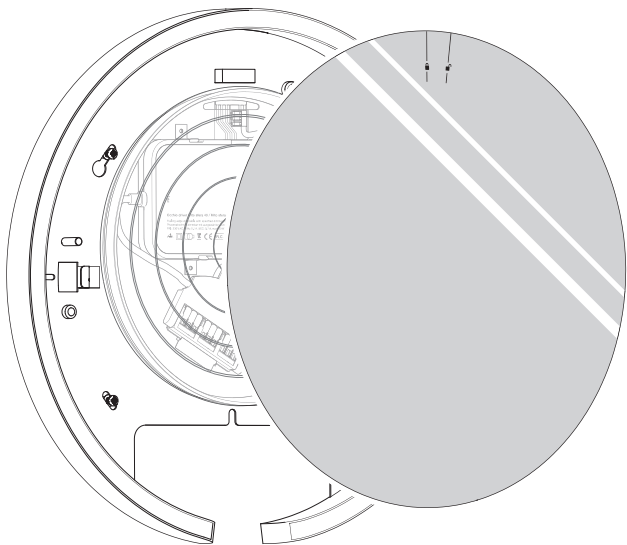

**Spiegel anbringen, muss eben
aufliegen.**

Attach mirror, must lie flat.

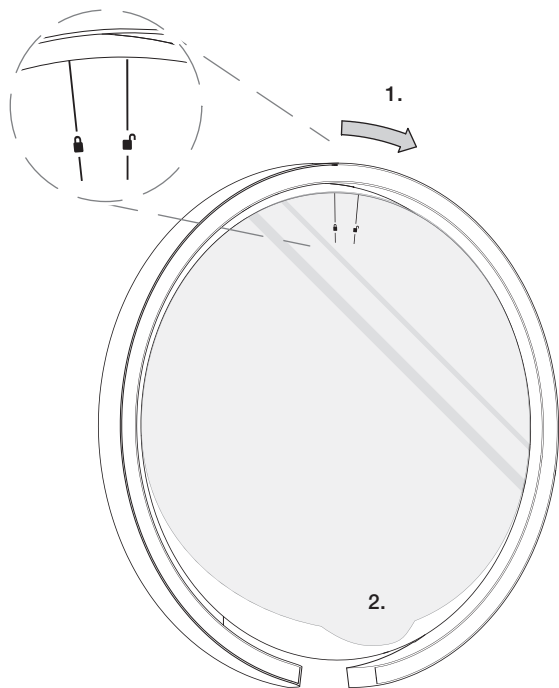

1. Spiegel nach rechts drehen zum fixieren.
2. Schutzfolie abziehen.

1. Turn the mirror to the right to fix it.
2. Pull off the protective foil.

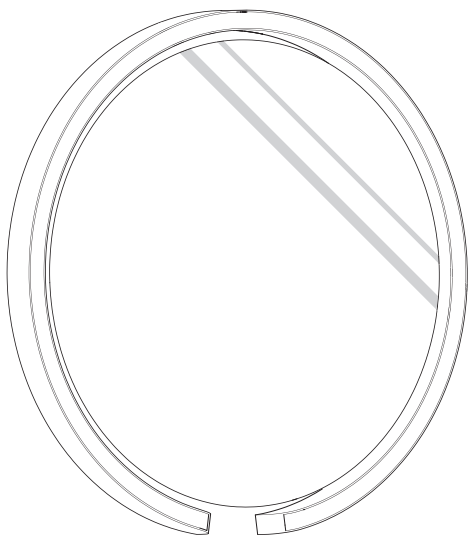

**Die Leuchte ist nun fertig
montiert.**

**The luminaire is now
completely assembled.**

Steuerung mit
der Occhio air
App (optional)

Control using
the Occhio air
app (optional)

Steuerung mit der Occhio air App (optional)

Control using the Occhio air app (optional)

Quick guide

Die Occhio air Produkte lassen sich mit der Occhio air App einrichten und steuern.

App installieren, App öffnen und angeschlossene Leuchten einrichten.

Occhio air products can be set up and controlled using the Occhio air app.

Install App, open App and set up connected luminaires.



Occhio air tutorials

www.occhio.com/air-tutorials

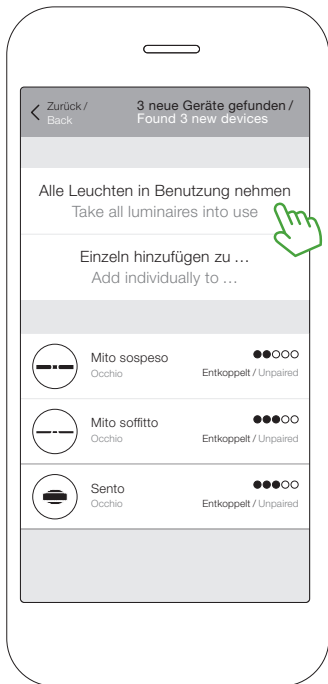

Ein Netzwerk (mein Netzwerk) wird autom. erstellt.

A network (my network) is autom. created.

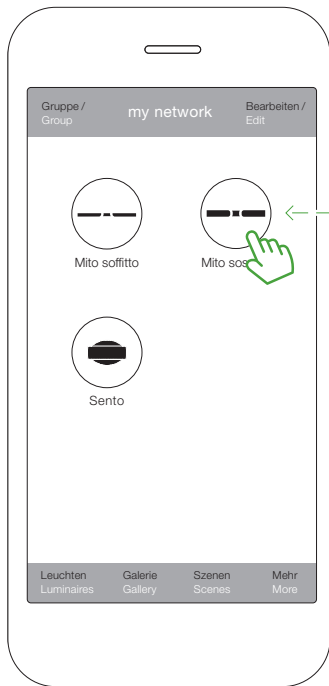

Steuerungsgesten Control gestures

on / off
on / off



antippen
tap

dimmen
dim



wischen
swipe

up / down
faden *



wischen
swipe

color tune **
magic move ***



halten
hold



wischen
swipe

Nur bei Leuchten mit beidseitigem Lichtaustritt *,
color tune ** oder magic move ***

Only for luminaires with double-sided light output *,
color tune ** or magic move ***

Und so werden die Leuchten gesteuert.
And so the luminaires are controlled.

Steuerung mit der Occhio air App (optional) Control using the Occhio air app (optional)

Nutzung auf mehreren Geräten

Use on several devices

Optional können Sie nun ihr
erstelltes Netzwerk (mein
Netzwerk) mit Anderen teilen.

Optionally, you can now share
your created network (my
network) with others.

1. Netzwerknamen
vergeben

1. Assign name

Occhio air tutorials

www.occhio.com/air-tutorials

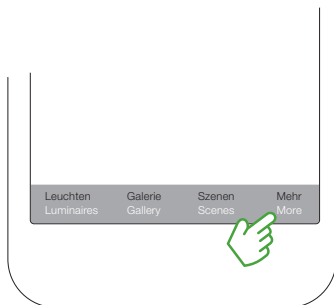

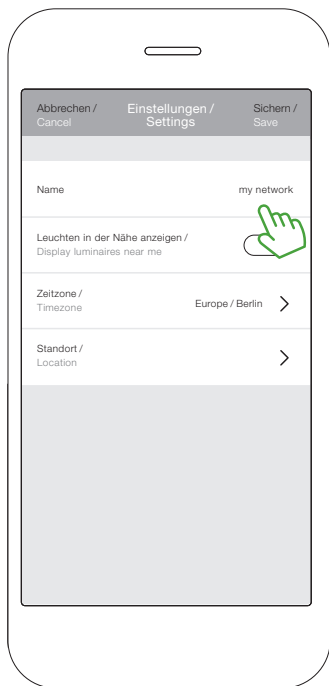

Netzwerkconfiguration → Netzwerkeinstellungen → Namen eingeben → Sichern
Network setup → Network settings → enter name → save

Steuerung mit der Occhio air App (optional) Control using the Occhio air app (optional)

Netzwerk freigeben und schützen

Share and protect the
network

Occhio air tutorials

www.occhio.com/air-tutorials

2. Netzwerk freigeben
2. Share network

Leuchten Luminaires	Galerie Gallery	Szenen Scenes	Mehr More
------------------------	--------------------	------------------	--------------



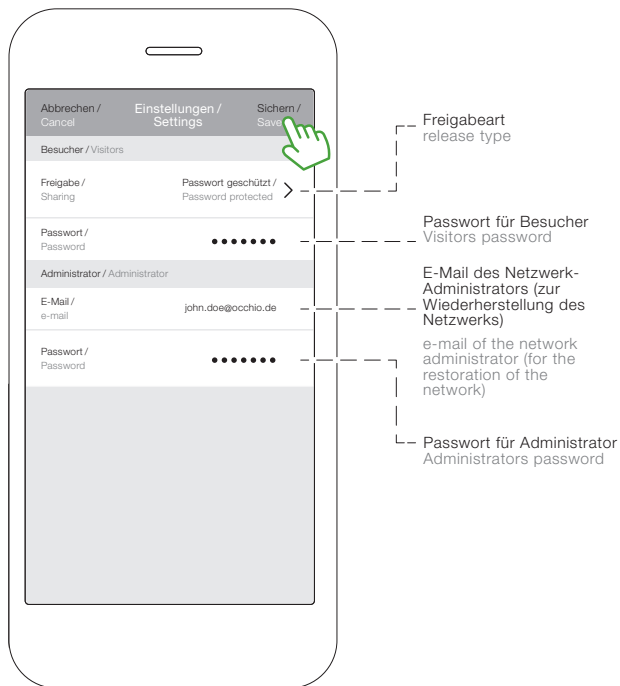

Netzwerkconfiguration → Freigabeoptionen → Passwort geschützt → Sichern
 Network setup → Sharing settings → Password protected → save

Steuerung mit
dem Occhio air
controller
(optional)

Control using
the Occhio air
controller
(optional)

Steuerung mit dem Occhio air controller (optional)

Control using the Occhio air controller (optional)

Occhio air controller

Intuitiv bedienbare Fernbedienung mit vier programmierbaren Tasten (Einrichtung via Occhio air App). Unabhängig von der App können einzelne Leuchten, Gruppen und Szenen gesteuert werden. Optional mit Wandhalterung erhältlich.

Maximaler Bedienkomfort und umfassende Steuerung via Bluetooth 4.0 (Bluetooth Low Energy). Schalten, dimmen, faden, color tune von einzelnen Leuchten, Gruppen und Szenen.

Occhio air controller

Intuitive remote control with four programmable buttons (setup via Occhio air app). Individual luminaires, groups and scenes can be controlled regardless of the app. Available with optional wall mount.

Maximum ease of use and total control via Bluetooth 4.0 (Bluetooth low energy). Switching, dimming, fading, color tune of individual luminaires, groups and scenes.



Zum Einrichten des Occhio air controllers wird die Occhio air App benötigt. Eine Video-Kurzanleitung kann unter: www.occhio.com/air-tutorials aufgerufen werden.

To set up the Occhio air controller, the Occhio air app is required. A video quick start guide can be called up at www.occhio.com/air-tutorials.

schalten/switch



⏏ - ☰ einzelne Leuchten, Gruppen, oder Szenen schalten

⏏ - ☰ switch individual luminaires, groups or scenes

dimmen/dim



⊕ - ☰ einzelne Leuchten, Gruppen, oder Szenen dimmen

⊕ - ☰ dims individual luminaires, groups or scenes

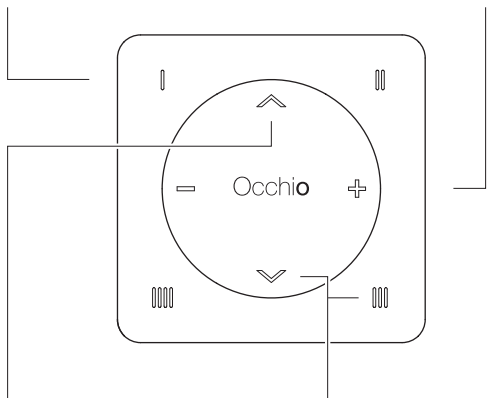

faden*



∧ ∨ einzelne Leuchten, Gruppen oder Szenen faden (up/down Verhältnis ändern)

∧ ∨ fades individual luminaires, groups or scenes (change up/down relation)

color tune**

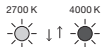

⏏ - ☰ and ∧ ∨ Farbtemperatur einzelner Leuchten, Gruppen oder Szenen einstellen

⏏ - ☰ and ∧ ∨ adjust color temperature of individual luminaires, groups or scenes

* Leuchten mit beidseitigem Lichtaustritt / luminaires with light emission on both sides ** Mito

Anhang

Appendix

Pflegehinweise

Care instructions

Leuchte nur in abgekühltem Zustand reinigen! Zur Reinigung der Leuchte ein trockenes Mikrofasertuch verwenden. Detaillierte Pflegehinweise sind unter www.occhio.com/de/company/faq zu finden.

Always allow the luminaire to cool down before cleaning! To clean the luminaire, use a dry microfibre cloth. Detailed care instructions are available at www.occhio.com/en/company/faq.

Info & Kontakt

Information & contact





Weitere Fragen beantwortet gerne
Ihr Occhio Fachhändler

Your Occhio specialist retailer will
gladly answer any other questions

www.occhio.com
info@occhio.com

Technische Daten

Technische Daten Leuchte

Artikelbezeichnung	Mito sfera 40, Mito sfera 60
Abmessungen	ø head 400 mm, ø head 600 mm H 30 mm
Schutzklasse	2
Anschluss	230 V AC
Dimmung	via Phasenabschnittdimmer, »touchless control« oder Occhio air (Liste kompatibler Dimmer: www.occhio.com/dim , Phasenabschnittdimmer und Occhio air sind nicht kombinierbar)
Material	Aluminium lackiert oder PVD-beschichtet, optisches Silikon, verspiegeltes Glas
LED-Leistung	Mito sfera 40: 20 W Mito sfera 60: 40 W
Zulässige Betriebsbedingung	max. 30°C nur im Innenbereich betreiben
Prüfzeichen	IP44 CE    

Technische Daten Leuchtmittel



Leuchtmittel	Occhio »color tune« LED
Ausführung	LED-board
Lebensdauer	> 50.000 Std.

Entsorgung

Bei örtlicher Entsorgungsstelle entsorgen. Mito sfera ist recyclebar; RoHS-konform. **Nicht in den Hausmüll geben!**

Technical data

Technical data luminaire

Product designation	Mito sfera 40, Mito sfera 60
Dimensions	ø head 400 mm, ø head 600 mm H 30 mm
Safety class	2
Connection	230 V AC
Dimming	via trailing-edge phasecut dimmer, »touchless control« or Occhio air (For a list of compatible dimmers, see www.occhio.com/dim_en , trailing-edge phasecut dimmer can not be combined with Occhio air)
Material	aluminium painted or PVD-coated, optical silicone, mirrored glass
LED power	Mito sfera 40: 20 W Mito sfera 60: 40 W
Permitted operating conditions	max. 30°C for indoor use only
Test symbols	IP44 CE F   

Technical data light source

Light source	Occhio »color tune« LED
Version	LED-board
Lifetime	> 50.000 h

Disposal

Dispose of at a local disposal site. Mito sfera is recyclable and RoHS compliant. **Do not dispose of with the household waste!**

Occhio

www.occhio.com



010405944518997510