

# ROD Wall

Design Jean-Marc da Costa & Manfred Wolf

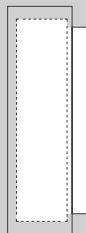

D

Vor Montage, Leuchtmittelwechsel und Reinigung Leuchte vom Netz trennen!  
Die Leuchte nur im Innenbereich einsetzen! Nur von Elektrofachkraft anzuschließen!

GB

Prior to assembly, changing the lamp or cleaning the luminaire please detach it from the mains. For indoor use only. Installation by qualified personnel only.

F

Prière de couper le courant avant tout montage, changement d'ampoule et nettoyage.  
Ce luminaire est réservé à un usage en intérieur. Installation par personnel qualifié uniquement.

I

Scollegare la lampada dalla rete elettrica prima del montaggio, della sostituzione del corpo illuminante e della pulizia. La lampada è adatta esclusivamente per interni. Installazione da personale qualificato solo.

E

Antes de proceder al montaje, el cambio de bombilla o la limpieza desconecte la lámpara de la red eléctrica. Instale la lámpara sólo en un lugar interior. Instalación solamente por personal calificado.

NL

Voor montage, vervanging en reiniging de lamp van het stroomnet loskoppelen.  
De lamp alleen binnen gebruiken. Om alleen te verbinden door een erkend elektricien.



2x



2x

01



Ø 6 mm

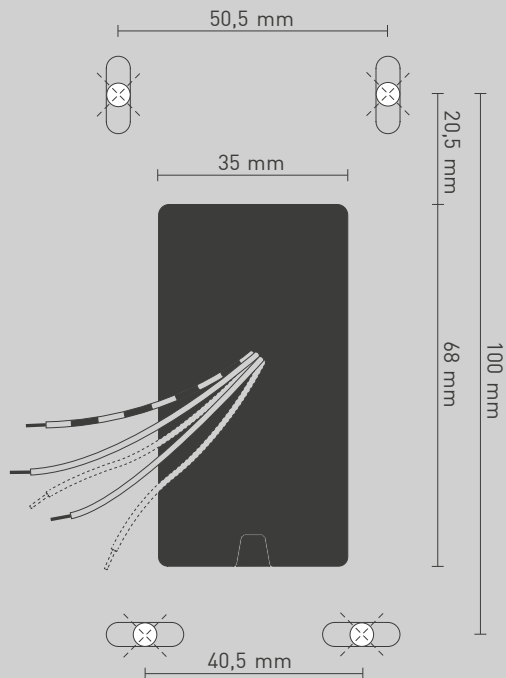

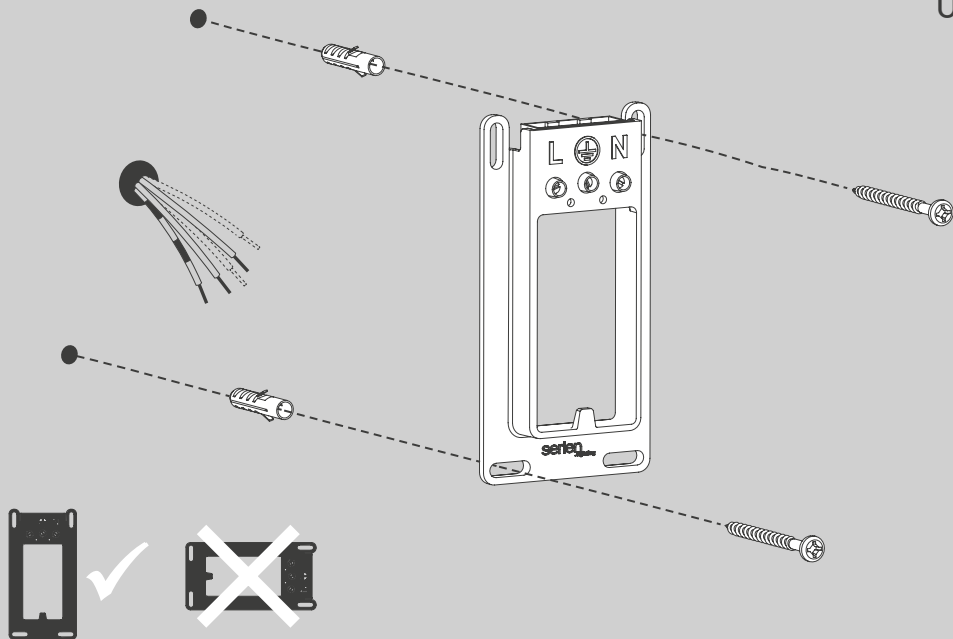

03

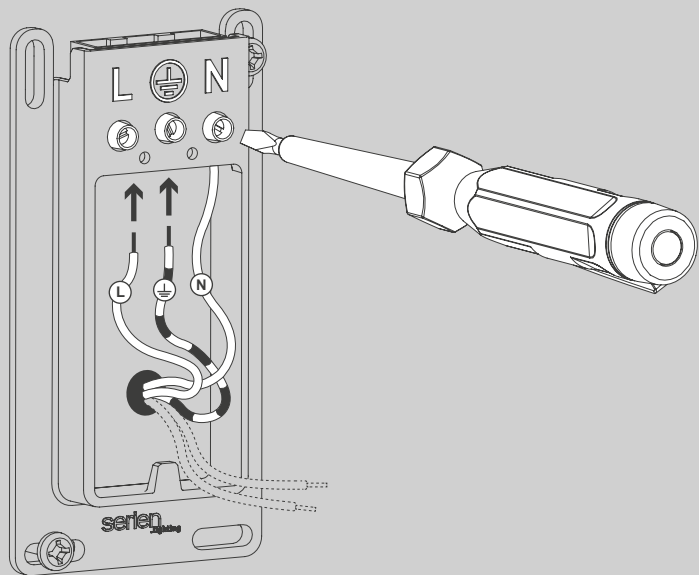

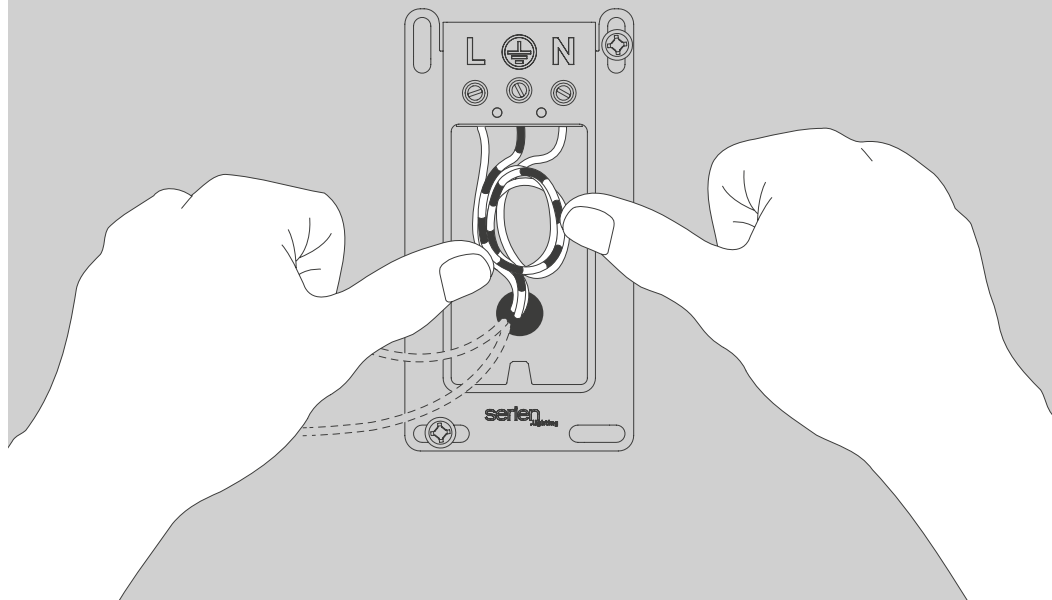

05

26W  
Ⓢ 1-10V

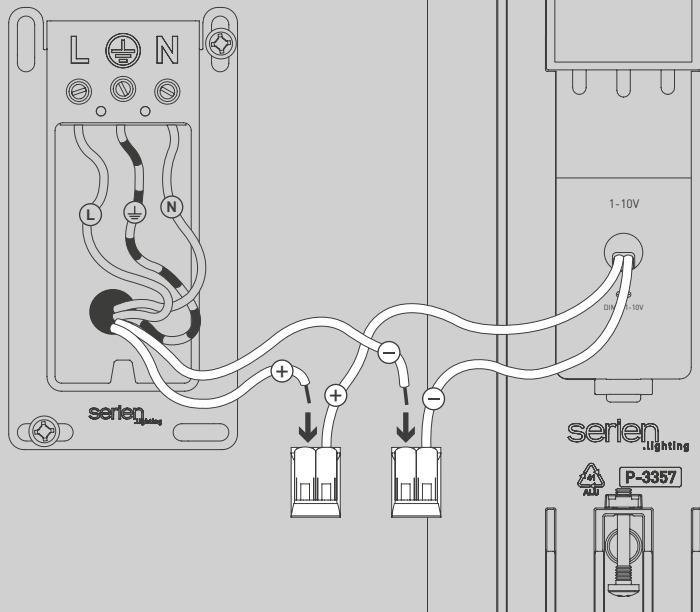



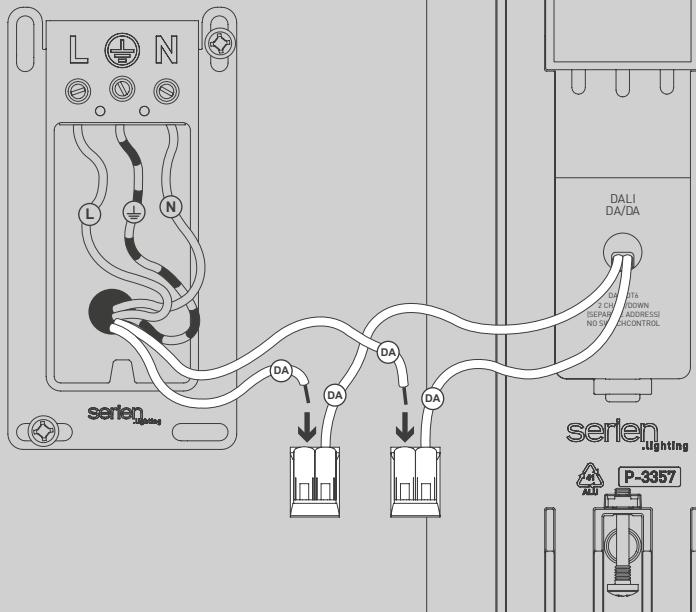

26W  
© DALI

05

26W  
© 1ch.  
TRIAC

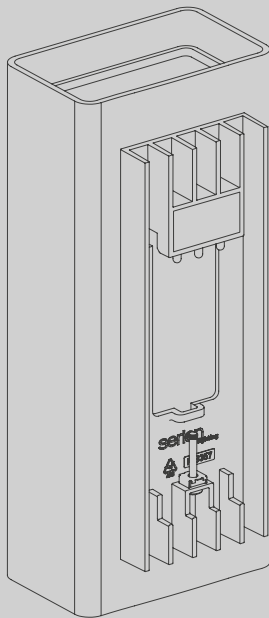

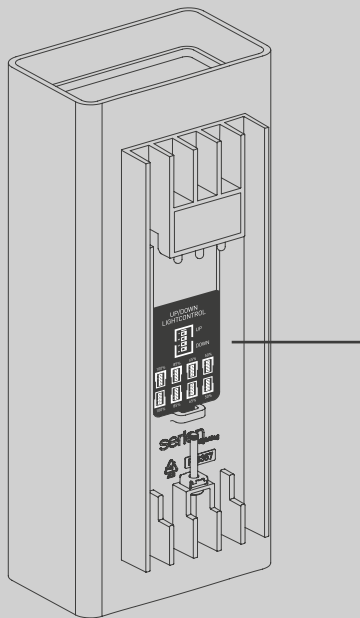

## UP/DOWN LIGHT CONTROL

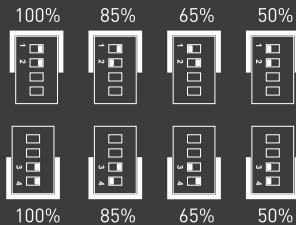
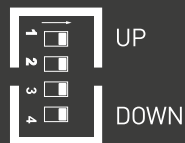

26W  
© 2ch.  
TRIAC

06

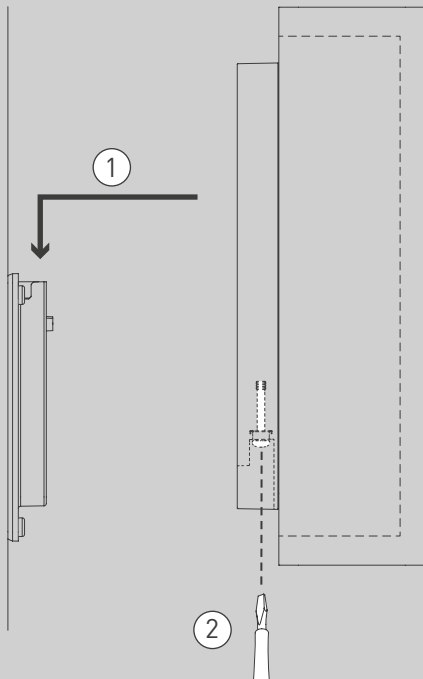

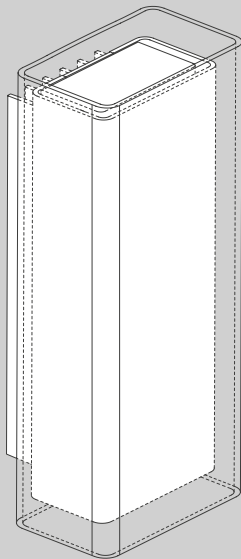

## CARE INSTRUCTIONS



Trennen Sie die Leuchte vor der Reinigung von der Stromversorgung.

Disconnenct electricity before cleaning.



Zum Reinigen bitte nur mit einem nebelfeuchten Tuch abwischen.  
Keine lösemittelhaltigen Reiniger verwenden!

Please solely use a damp cloth for cleaning. Do not use solvenwt  
containing detergent!

01

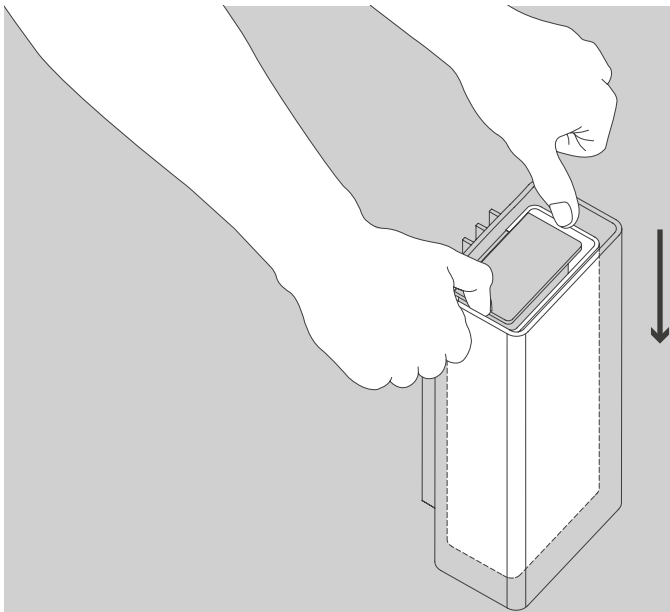

02

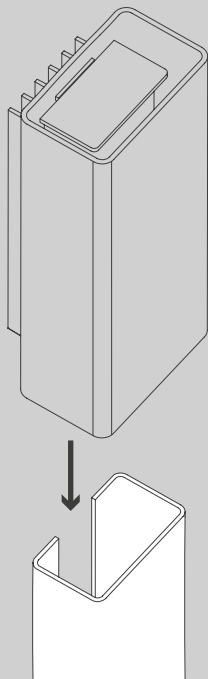



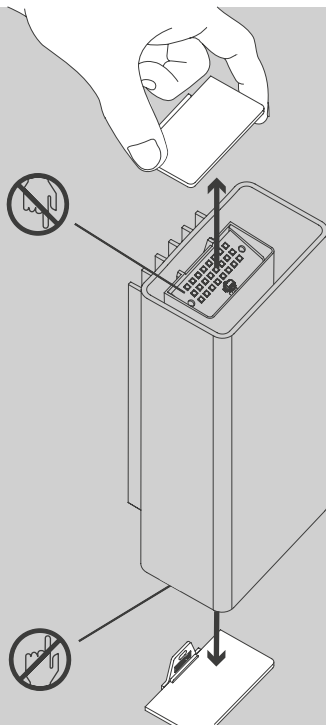

04

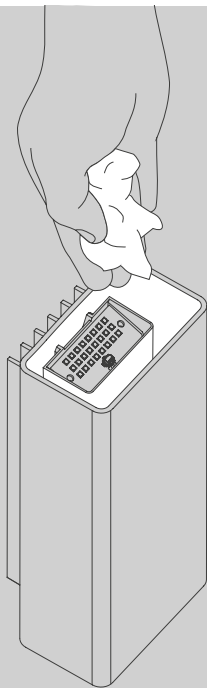

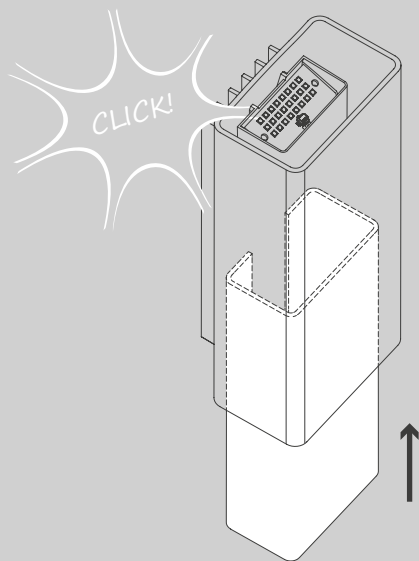

06

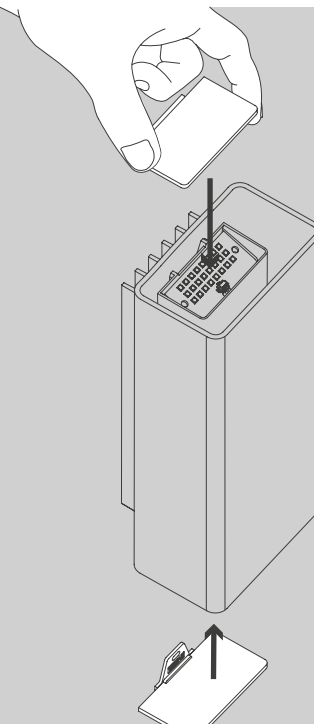

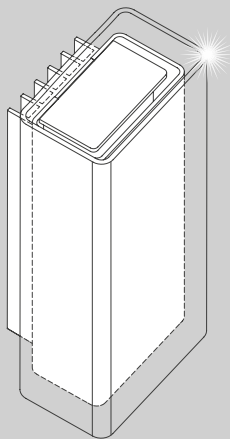



Die durchgestrichene Mülltonne weist darauf hin, dass dieses Elektrogerät nicht im Hausmüll entsorgt werden darf.

Um die menschliche Gesundheit und die Umwelt vor möglichen Gefahrstoffen zu schützen, kann dieses Produkt am Ende seiner Lebensdauer kostenfrei bei einer Sammelstelle in Ihrer Nähe abgegeben werden.

Die gesonderte Entsorgung ermöglicht die Wiederverwendung bzw. Verwertung von Elektrogeräten.

- D Technische Änderungen und Irrtümer vorbehalten.
- GB Subject to technical modifications and errors.
- F Sous réserve de modifications techniques et d'erreurs.
- I Ci riserviamo eventuali modifiche tecniche o errori.
- E Se reserva el derecho a realizar modificaciones técnicas.
- NL Error en technische wijzigingen voorbehouden.

## ROD Wall

mm

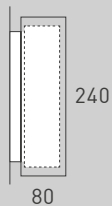

kg

1,3



**26W**

CRI > 90  
2700K

primär/primary 220 - 240V, 50 - 60Hz

Andere Lichtfarben und Farbwiedergabeindizes auf Anfrage



serien  
.lighting

serien Raumleuchten GmbH Hainhäuser Str. 3-7 63110 Rodgau Germany Tel +49 (0)6106 6909 0 [www.serien.com](http://www.serien.com)