















Leistung	32W
Betriebsspannung	220 / 240 V AC 50Hz
Grundisolation: die zugänglichen leitenden Bestandteile sind mit einem Erdleiter verbunden, Erdung zwingend erforderlich.	
Austausch, Ein- und Ausbau sowie Bedienung der Lampe/Led-Netzstecker ziehen oder die Lampe vom Stromkreis entfernen.	

<p> Schutzart IP 20, Schutz gegen Ø12 mm, kein Schutz gegen Regenwasser.</p> <p> Stromleitende Teile dürfen nicht feucht werden, Flächen wie Lampenschirm, Glas, Reflektoren und Abdeckungen können mit einem weichen Tuch ohne Reinigungsmittel gesäubert werden. Die Lampe gegen Feuchtigkeit schützen.</p> <p> ACHTUNG Das Gerät darf nicht als unsortierter Stedlungsabfall entsorgt werden. Zum Schutz der Umwelt muss es getrennt einer Sammelstelle abgegeben werden. Gemäß der Richtlinie 2012/19/UE und den entsprechenden nationalen Gesetzen über die Entsorgung von Altgeräten ist die Nichterhaltung strafbar. Bitte informieren Sie sich über die örtlichen Sammelstellen für Elektroprodukte und elektronische Geräte.</p> <p> Das LED-Modul in dieser Leuchte enthält darf nur vom Hersteller ersetzt werden. Sie sich bitte an Ihren Lieferanten.</p> <p> Achtung, Gefahr eines elektrischen schtages.</p>	<p> Attention, risque de choc électrique.</p>
--	--

Puissance	32W
Tension	220 / 240 V AC 50Hz
Isolation fondamentale : les éléments conducteurs accessibles sont reliés à un conducteur de terre. Mise à la terre obligatoire.	
Installation, entretien de l'appareil et/ou remplacement de l'ampoule/Led, Avant toute opération, débrancher la prise de courant ou couper l'alimentation générale de la distribution d'électricité.	

<p> Index de protection IP 20, Protection contre l'humidité. Les surfaces électriques ne doivent jamais entrer en contact avec l'humidité. Les surfaces corpores solides de Ø ≥ 12 mm, doivent être protégées contre la pluie. Marquage non prévu sur l'appareil.</p> <p> ATTENTION L'appareil ne doit pas être éliminé comme simple déchet urbain mais conformément à la collecte sélective pour garantir la protection de l'environnement. Conformément à la Directive 2012/19/UE et aux dispositions légales qui s'y rapportent, les contreparties aux sa durée de vie, les contreparties aux dispositions en vigueur sont passibles des sanctions prévues par la loi. Veuillez vous informer du système local de séparation de déchets électriques et électroniques.</p> <p> Attention, risque de choc électrique.</p>	<p> Attention, risk of electric shock.</p>
---	---

Power	32W
Operating voltage	220 / 240 V AC 50Hz
Fitting and maintaining the unit and/or replacing the bulb/Led, Before doing anything, always remove the lamp plug from its socket or turn off the lamp supply circuit, and leave the bulb to cool.	
Essential insulation: the accessible conductive parts are connected to an earth conductor. Grounding is mandatory.	

<p> Protection level IP 20, Protection is effective against contact with solid bodies of Ø ≥ 12 mm. No protection is provided on the luminaire.</p> <p> ATTENTION The product cannot be disposed as unsorted municipal waste. It must be collected separately to prevent negative environmental impacts. In accordance with the procedures of Directive 2012/19/UE and relevant national laws and regulations adopted pursuant to this Directive on the disposal of waste at the end of the life cycle of the product, any violation is sanctioned by law. Please inform yourself about the local separate collection system for electrical and electronic products.</p> <p> Caution, risk of electric shock.</p>	<p> Attention, risk of electric shock.</p>
--	---

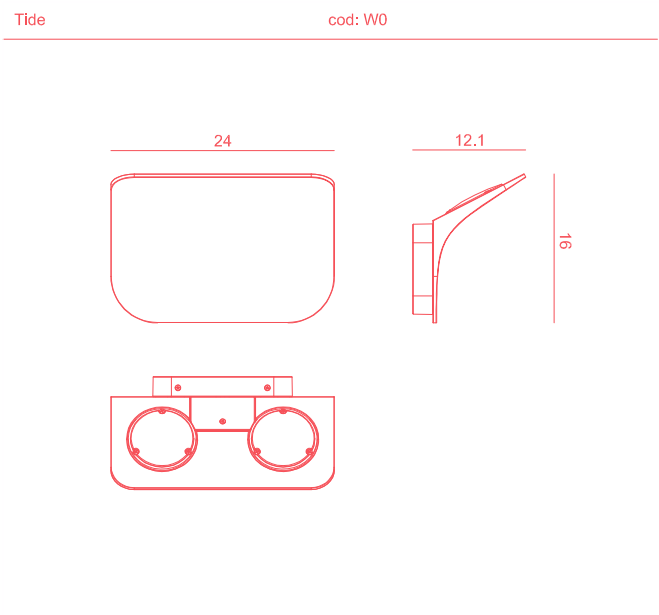

Light Source	ACRICHE DIM LED
Power	32 Watt
Kelvin	2.700, 3.000
Dimmer	phase
Lumen	2.660
CRI	90

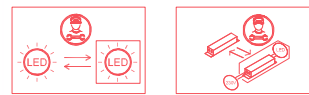

Tide design: Paolo Dell'elce

Made in Italy



- IT
- EN
- FR
- DE
- UE

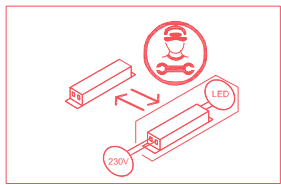

IT - Driver sostituibile solo da personale specializzato.

EN - Replaceable control gear by a professional.

DE - Durch einen Fachmann austauschbares Vorschaltgerät.

FR - Équipement de contrôle remplaçable par un professionnel.

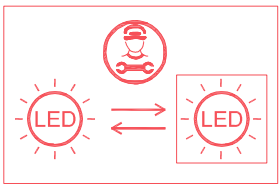





IT - LED sostituibile solo da personale specializzato.

EN - Replaceable (LED only) light source by a professional.

DE - Durch einem Fachmann austauschbare Lichtquelle (nur LED).

FR - Source de lumière remplaçable (LED) par un professionnel.

Potenza	32W
Tensione di funzionamento	220 / 240 V AC 50Hz
Isolamento fondamentale: le parti conduttive accessibili sono collegate ad un conduttore di terra. Messa a terra obbligatoria.	
Installazione, manutenzione dell'apparecchio e/o sostituzione della lampadine/sorgenti Led, Prima dell'apparecchio essere sempre la spina dalla presa di corrente o togliere l'alimentazione generale dell'impianto elettrico.	

<p> Protection level IP 20, Protection is effective against rain. No indications are provided on the luminaire.</p> <p> ATTENTION The product cannot be disposed as unsorted municipal waste. It must be collected separately to prevent negative environmental impacts. In accordance with the procedures of Directive 2012/19/UE and relevant national laws and regulations adopted pursuant to this Directive on the disposal of waste at the end of the life cycle of the product, any violation is sanctioned by law. Please inform yourself about the local separate collection system for electrical and electronic products.</p> <p> Caution, risk of electric shock.</p>	<p> Attention, risk of electric shock.</p>
--	---

LED IP 20

LED IP 20

LED IP 20

LED IP 20

6 - Questo prodotto contiene una sorgente luminosa di classe energetica F.

6 - This product contains an energy class F light source.

5 - Refer to the website www.rotaliana.it for instruction on how to replace the power packs, the light sources, and on how to disassemble the product at the end of its lifecycle.

4 - Rotaliana declines all responsibility for damage caused to things or persons by any improper use of the luminaire.

3 - The product must not be modified. Any change will nullify the safety guarantees and may make the luminaire dangerous.

2 - Keep the instructions for future needs. For any problems, get in touch with your supplier.

1 - Follow carefully the assembly and use instructions to guarantee a correct and safe function of the luminaire.

EN

6 - Questo prodotto contiene una sorgente luminosa di classe energetica F.

4 - Rotaliana declina ogni responsabilità per danni causati a cose o a persone da un non corretto uso dell'apparecchio.

3 - Il prodotto non deve essere modificato. Qualsiasi modifica annulla le approvazioni di sicurezza e può rendere pericoloso l'apparecchio.

2 - Conservare le istruzioni per future necessità. Per eventuali problemi contattare il rivenditore.

1 - Seguire attentamente le istruzioni di montaggio e d'uso per garantire un funzionamento corretto e sicuro dell'apparecchio.

IT

Rotalliana srl
via Trento 115 - 117
38017 Mezzolombardo
Trento, Italia

T. +39 0461 602376
info@rotaliana.it
rotaliana.it

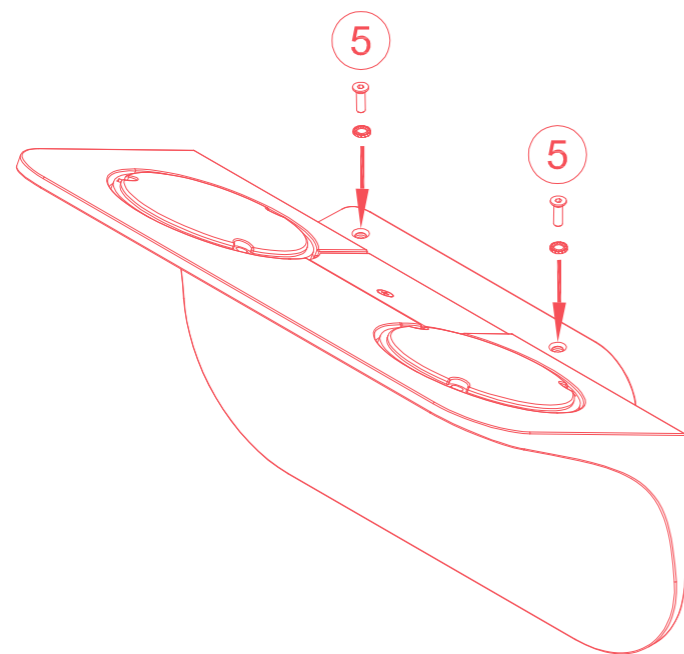
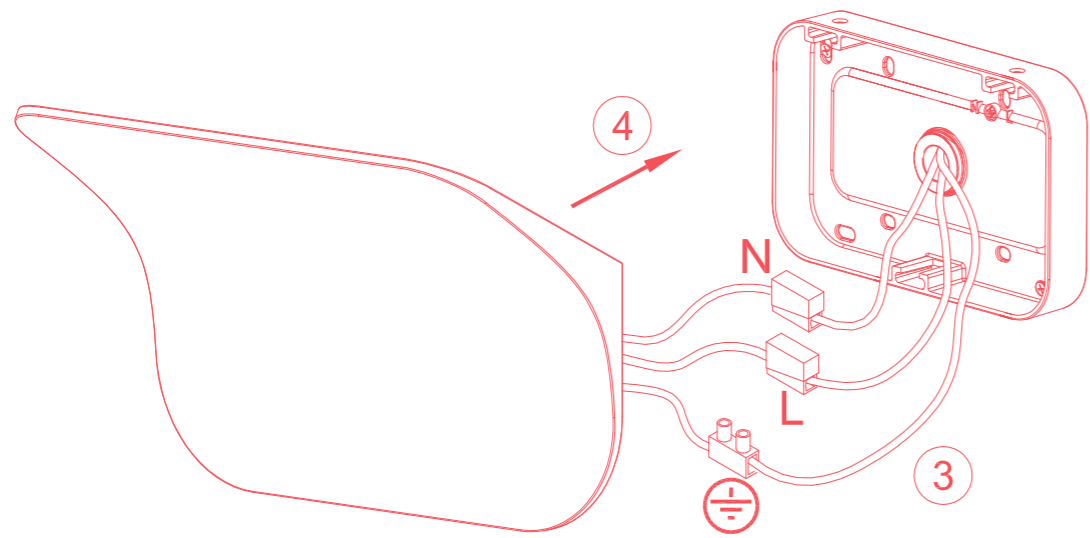
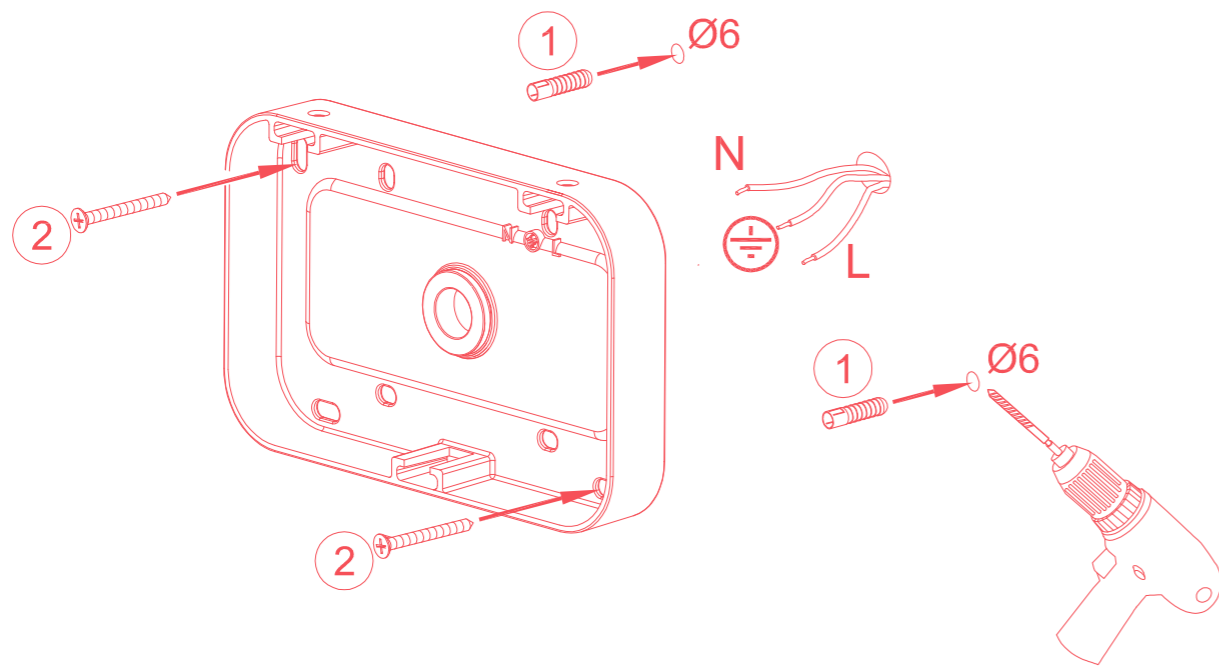

incluso/included

