

HOPE

design Francisco Gomez Paz / Paolo Rizzato

**LUCE
PLAN**

Type: Suspension

Light source: D66/12 - D66/18 105W HSGSA E27
23W FB E27
LED E27

D66/42 3 x 105W HSGSA E27
3 x 23W FB E27
3 x LED E27



D66/105 5 x 105W HSGSA E27
5 x 23W FB E27
5 x LED E27

Product use: Indoor

Materials: Structure in polished stainless steel and polycarbonate arms, methacrylate prismatic lenses

Colors: Transparent

Description: Incredibly light and easy to dismantle, Hope presents the magic of traditional chandeliers, reinterpreting them with sophisticated modern technologies and contemporary materials. A series of thin methacrylate Fresnel lenses multiply the light from the light source, recreating a pleasant, glittery and party-like atmosphere, sprinkled with thousands of tiny reflections.

Insulation class:  (D66/42 - D66/105)  D66/12 - D66/18)



Awards: Red Dot Design Award 2010, prize
Good Design Chicago Athenaeum, 2010
Premio dei Premi 2011, prize
Compasso d'Oro ADI 2011, prize

Reference code: D66/12 1D6612S00000
D66/18 1D6618S00000
D66/42 1D6642S00000
D66/105 1D66105S0000

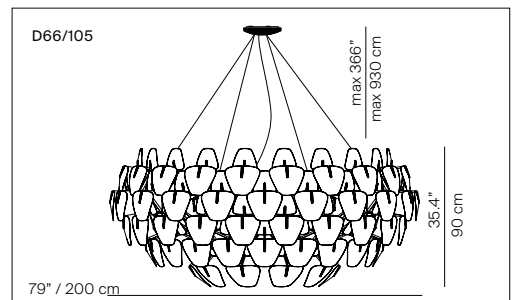
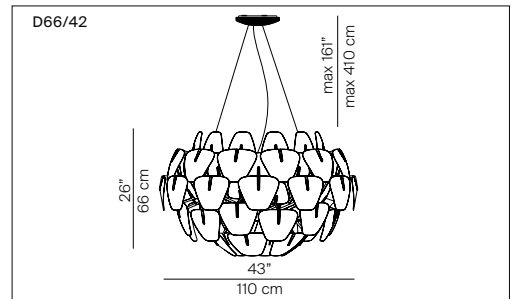
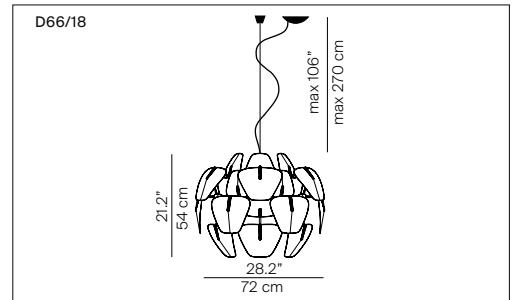
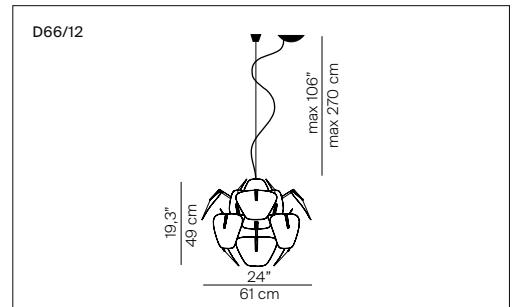

HOPE

design Francisco Gomez Paz / Paolo Rizzato

Composition Kit

A

D66/105

D66/42

D66/42

h tot min 400 cm

weight 23 kg

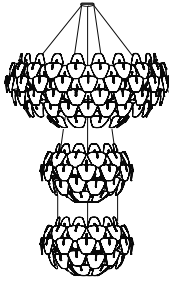

B

D66/105

D66/18

D66/18

h tot min 363 cm

weight 23 kg

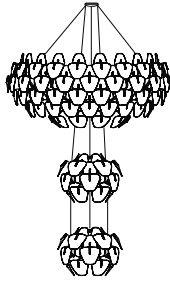

C

D66/105

D66/18

h tot min 364 cm

weight 27,5 kg

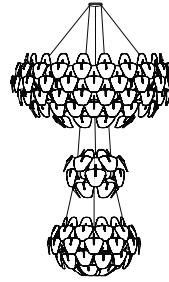

D

D66/105

D66/42

D66/18

h tot min

374 cm

weight 27,5 kg

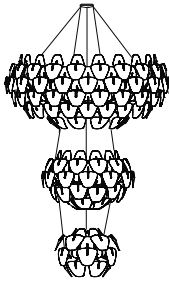

E

D66/42

D66/105

h tot min

325 cm

weight 32 kg

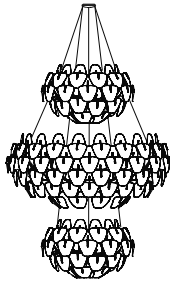

F

D66/42

D66/105

D66/18

h tot min

299 cm

weight 27,5 kg

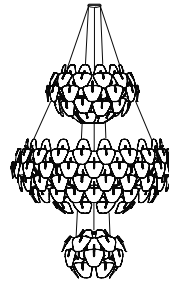

G

D66/18

D66/105

h tot min 324 cm

weight 27,5 kg

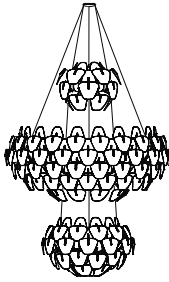

H

D66/18

D66/42

h tot min 249 cm

weight 27,5 kg

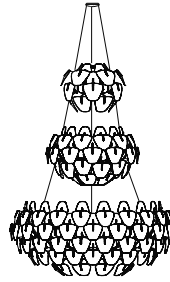

I

D66/42

D66/42

h tot min 245 cm

weight 21 kg

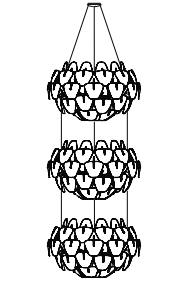

D66/18

D66/18

D66/105

h tot min 303 cm

weight 23 kg

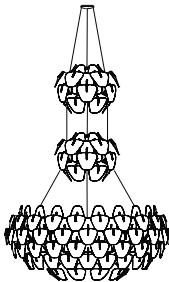

D66/42

D66/42

h tot min 229 cm

weight 16,5 kg

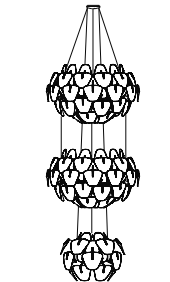

D66/42

D66/18

D66/42

h tot min 219 cm

weight 16,5 kg

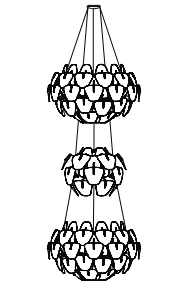

P

D66/18

D66/42

D66/18

h tot min 198 cm

weight 12 kg

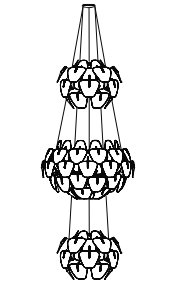

Q

D66/18

D66/18

D66/42

h tot min 198 cm

weight 12 kg

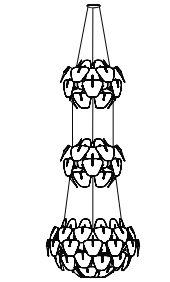

R

D66/42

D66/18

D66/18

h tot min 213 cm

weight 12 kg

