

# Artemide®

## Castore

design  
M. De Lucchi / H. Ubbens

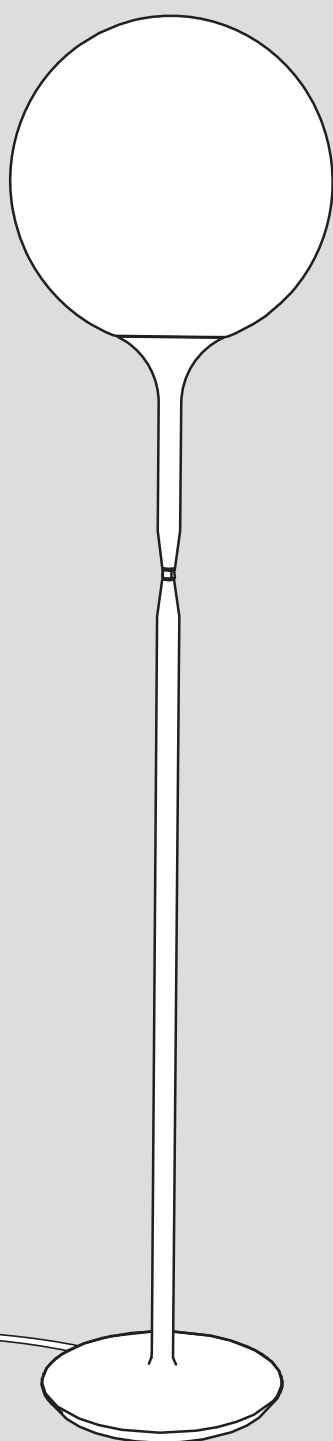



i

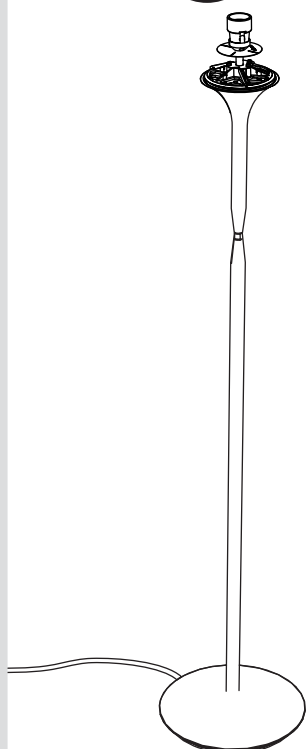
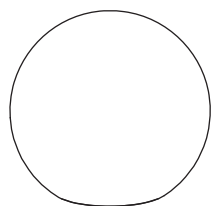
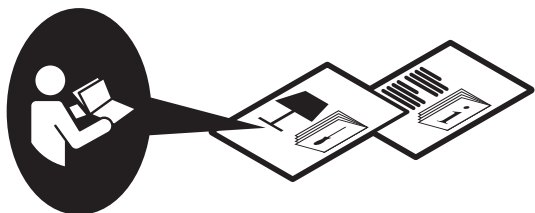
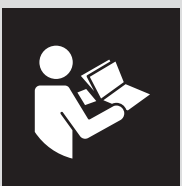
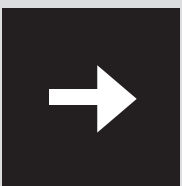
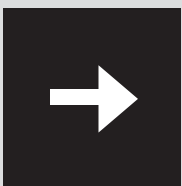
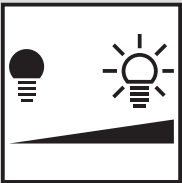
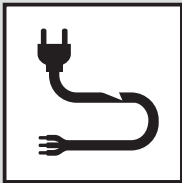
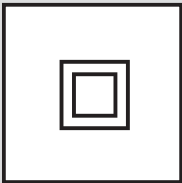

1

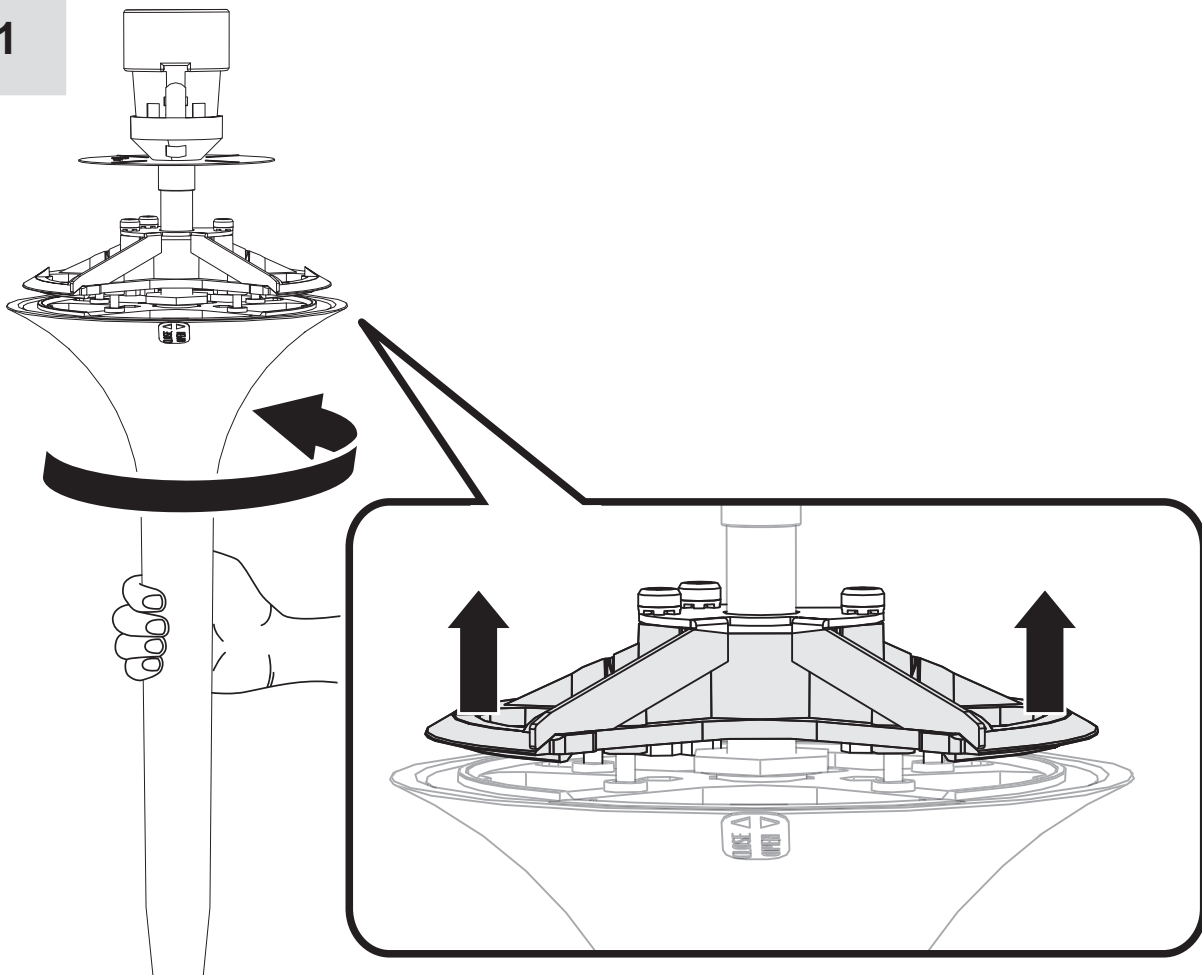

2

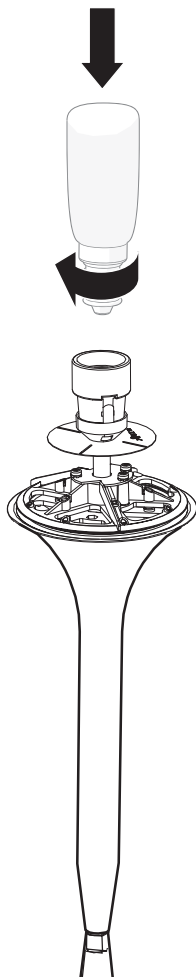

3

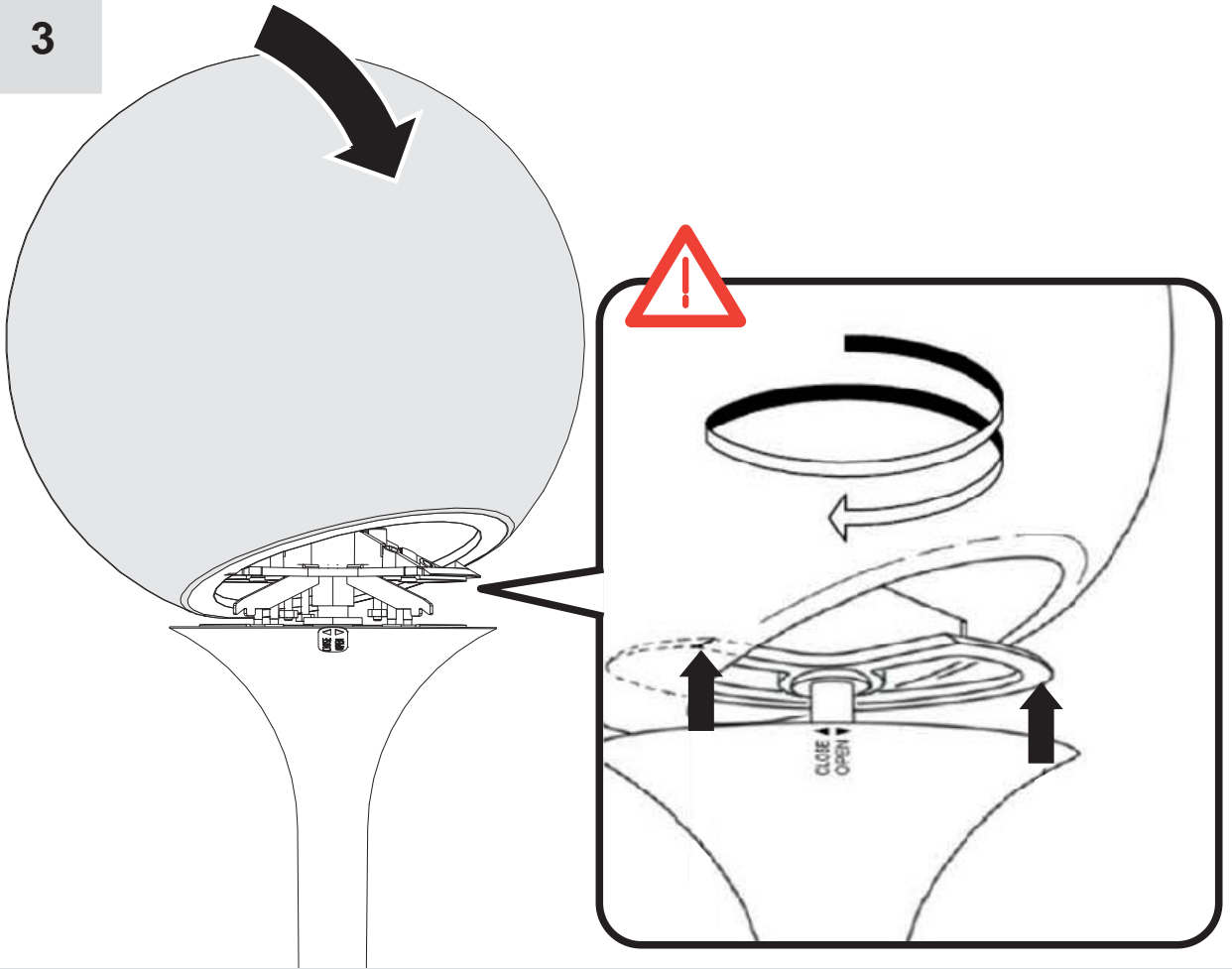

4

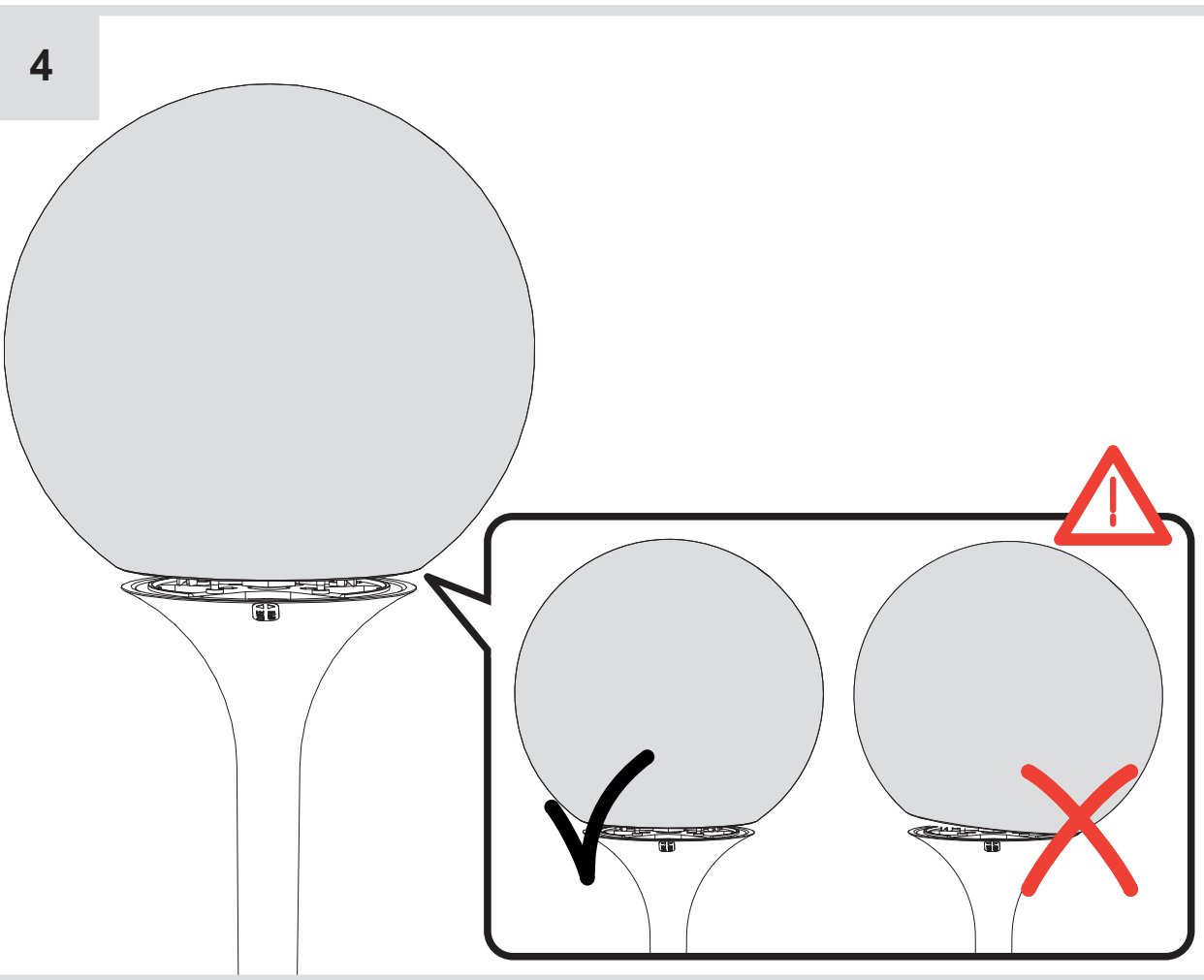

5

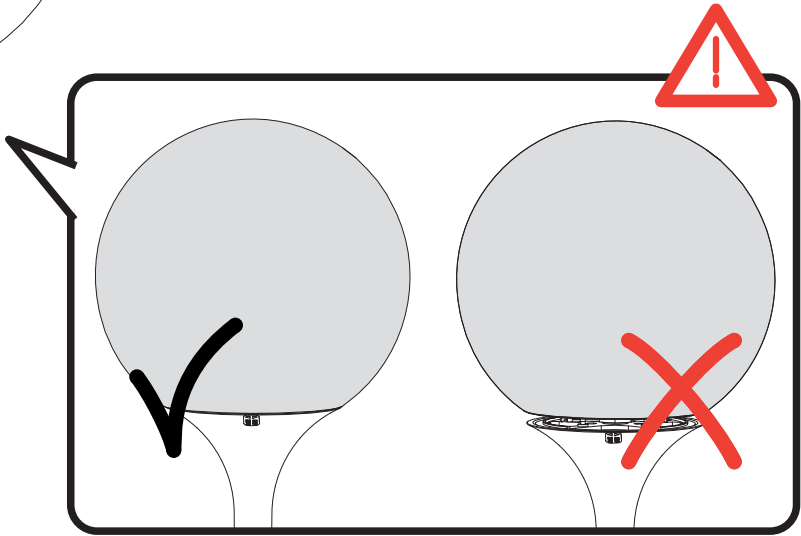
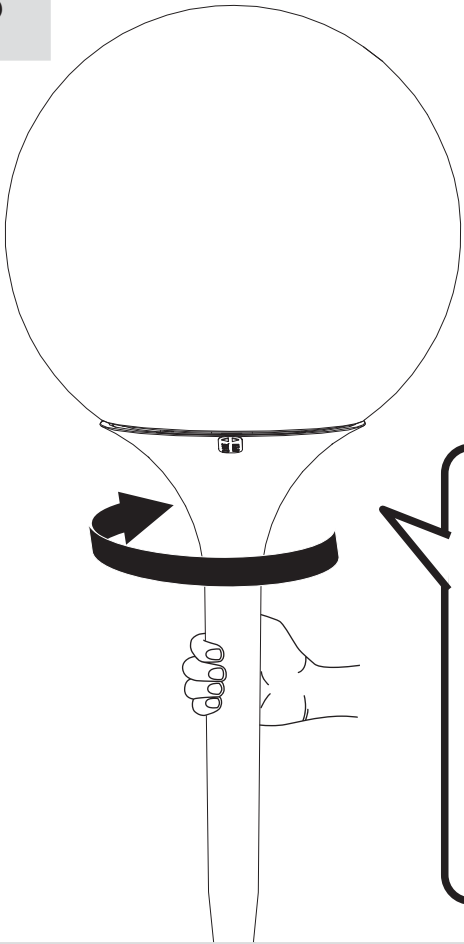

6

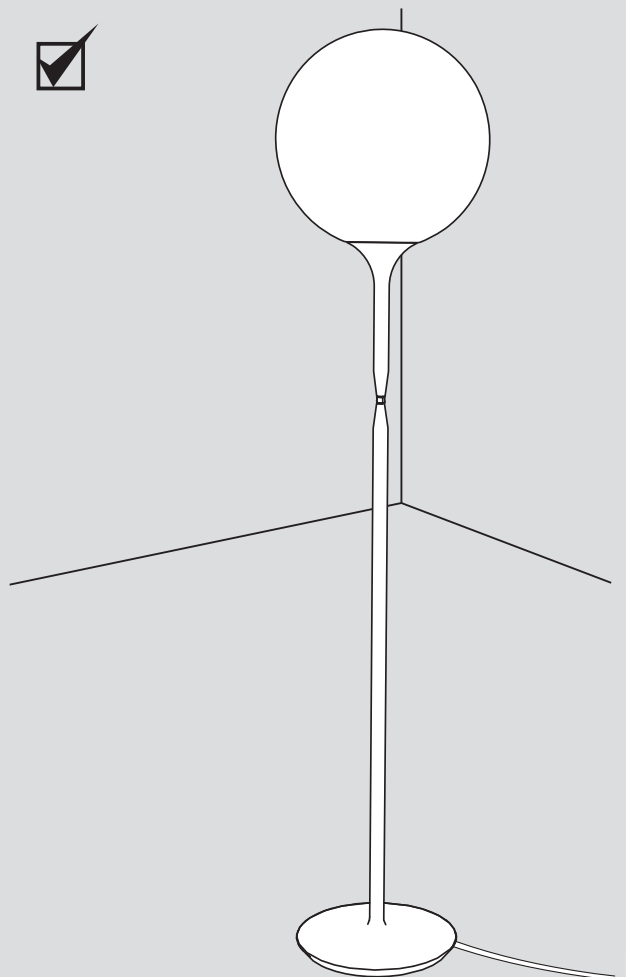
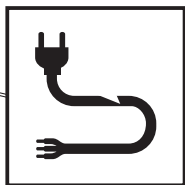
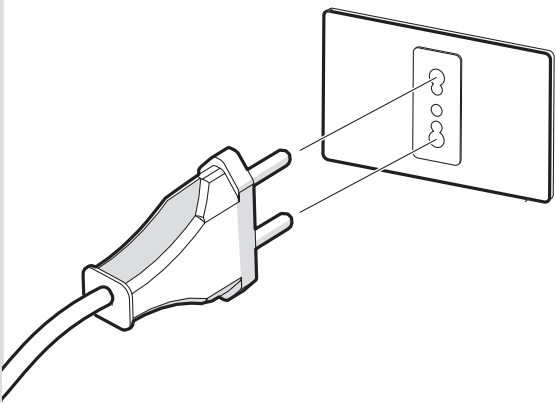



7a

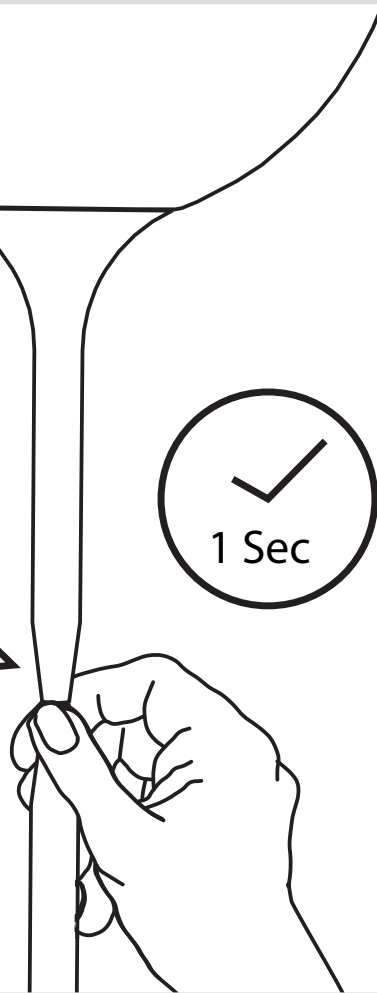
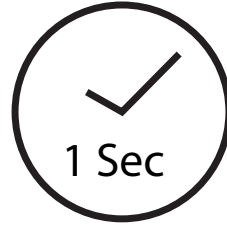
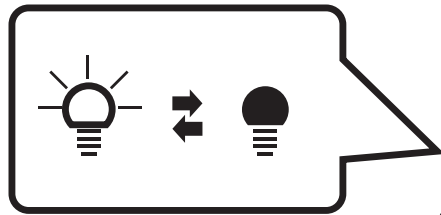

7b

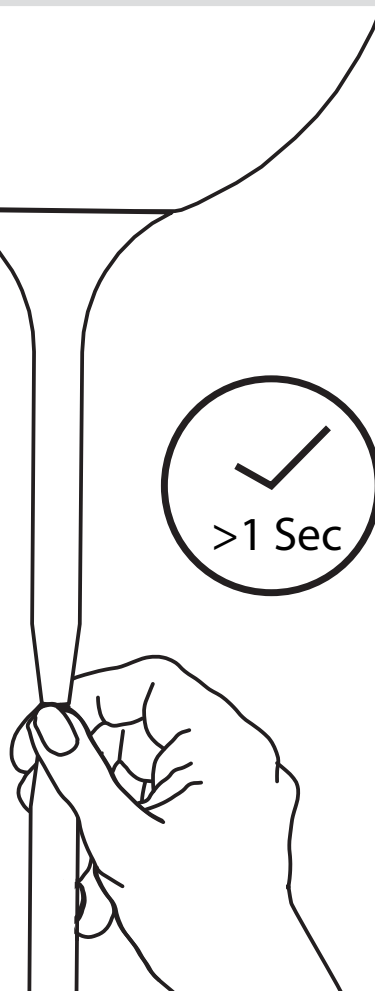
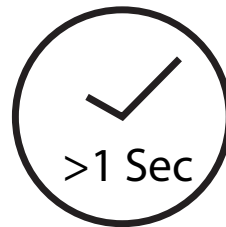
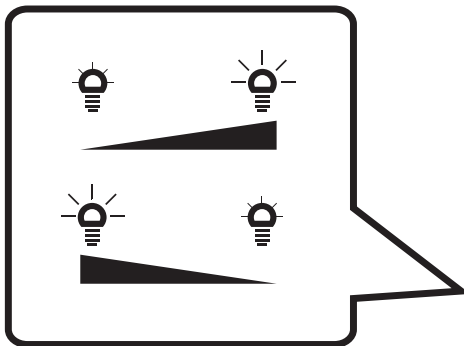

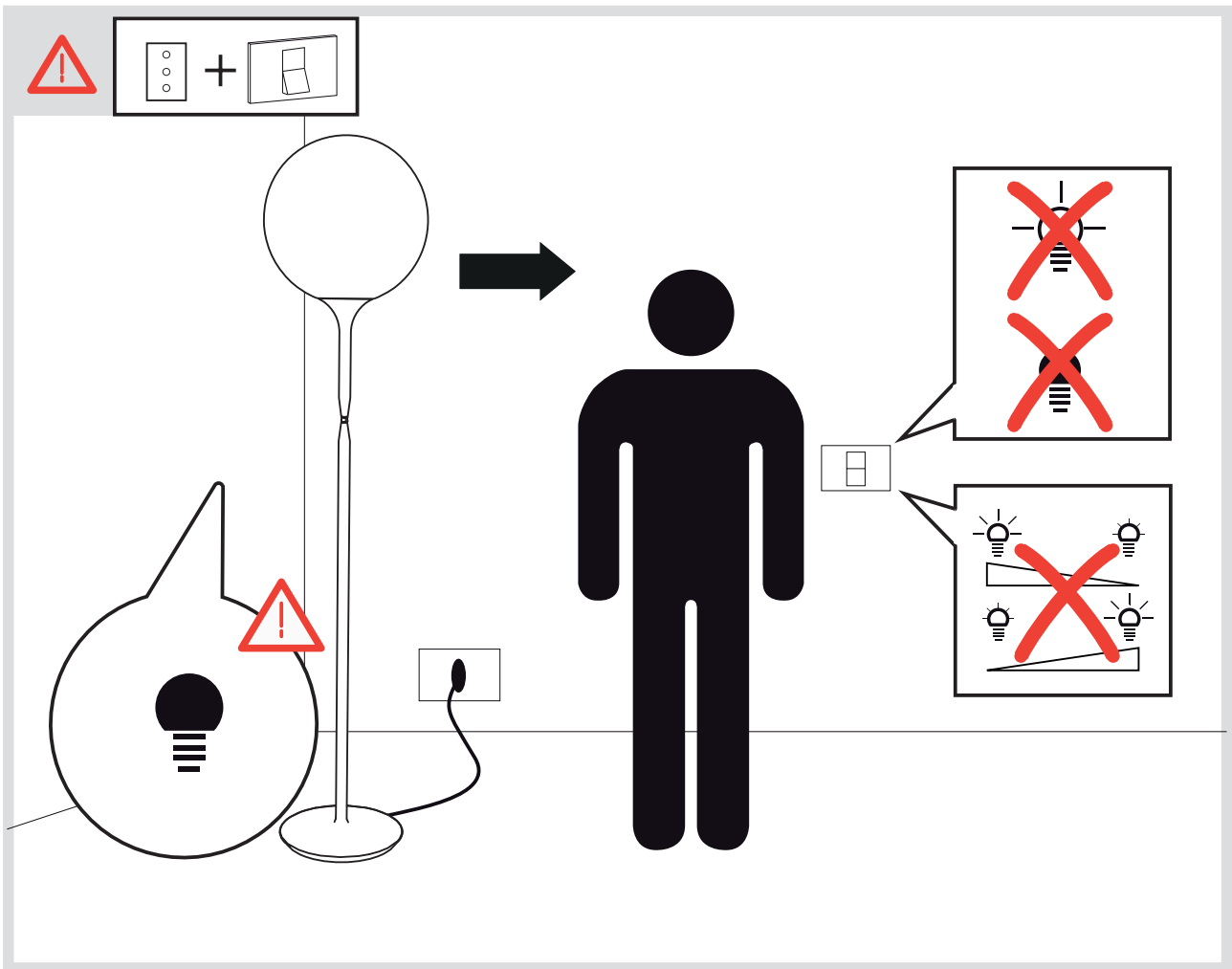
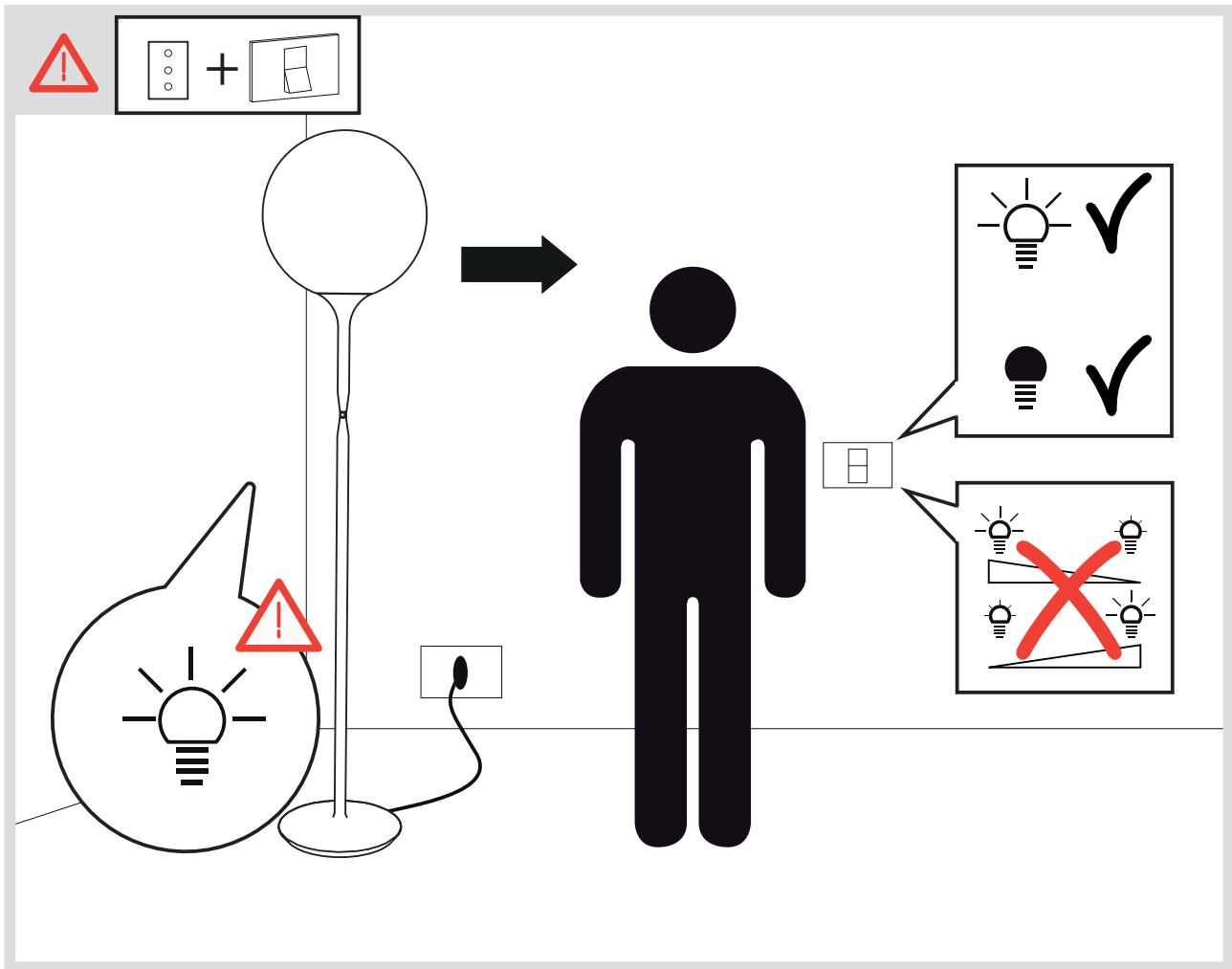



i

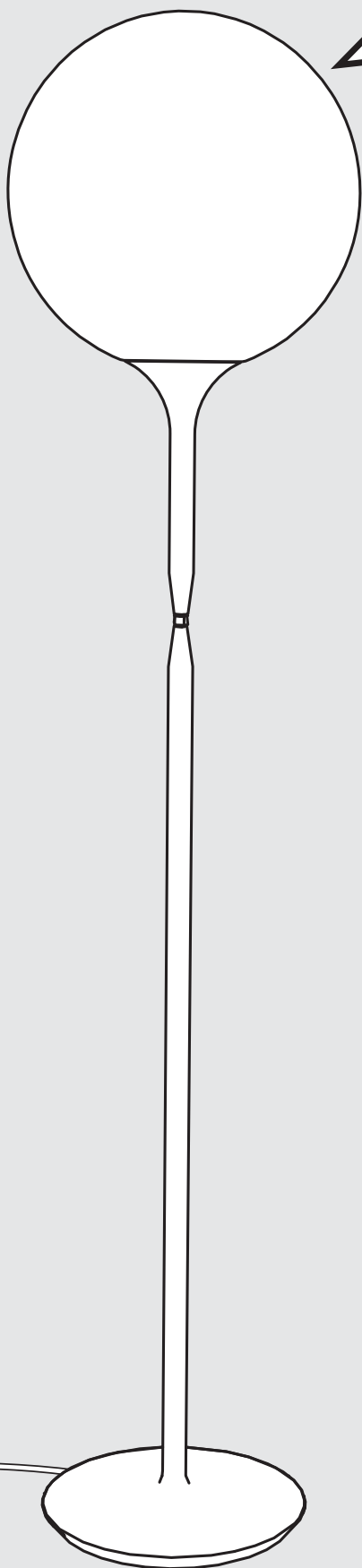

**MAX 150W - E27**

Halo: HSGST - 2900 lm  
LED: DRAA - 2500 lm



**MAX 205W - E27**

Halo: HSGST - 4200 lm  
LED: DRAA - 2500 lm





1

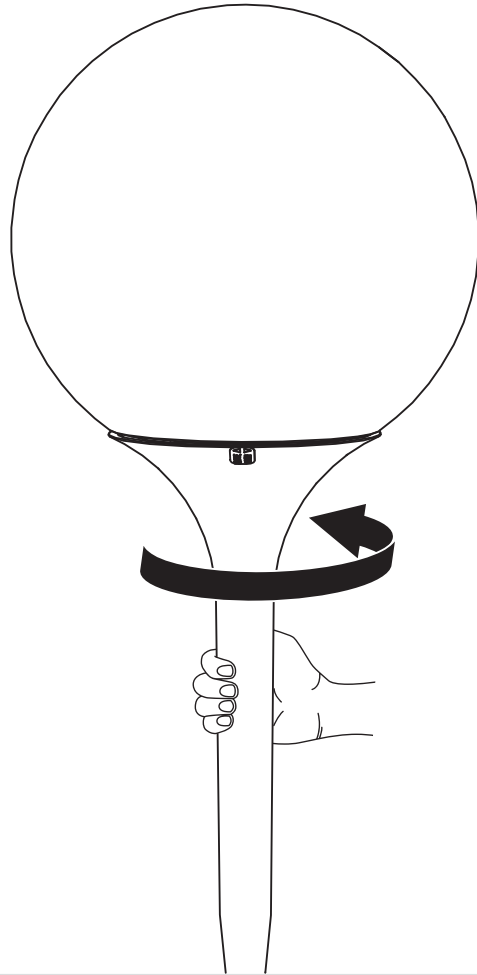

2

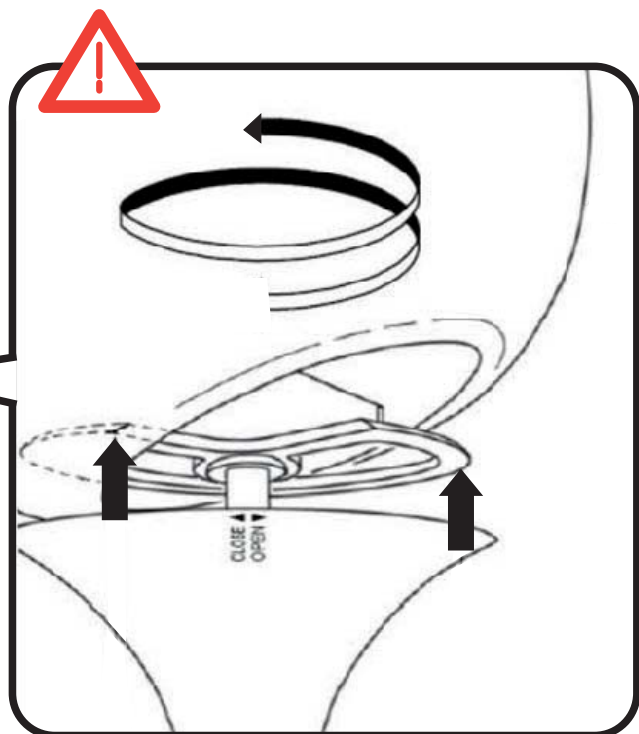
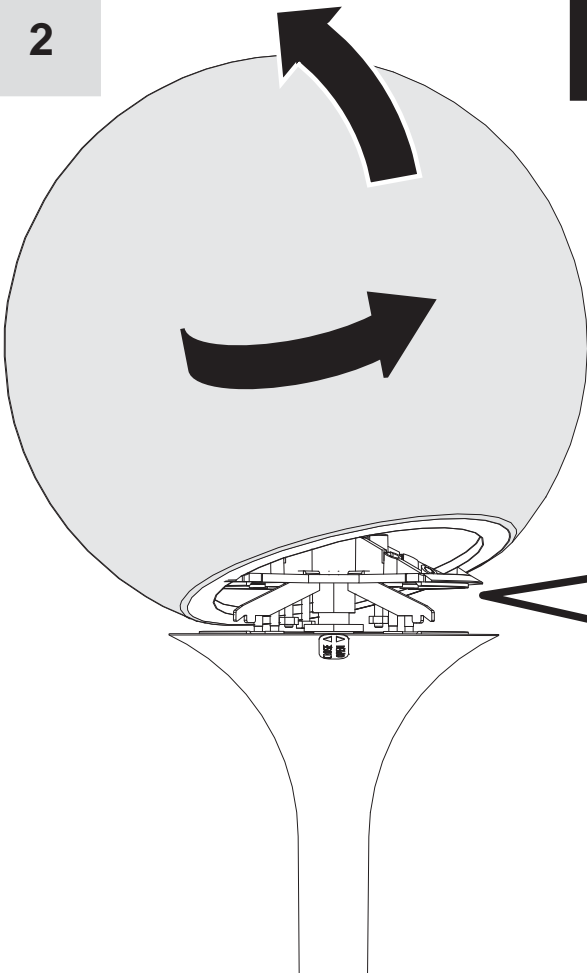
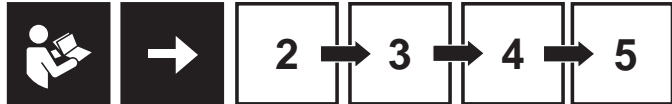

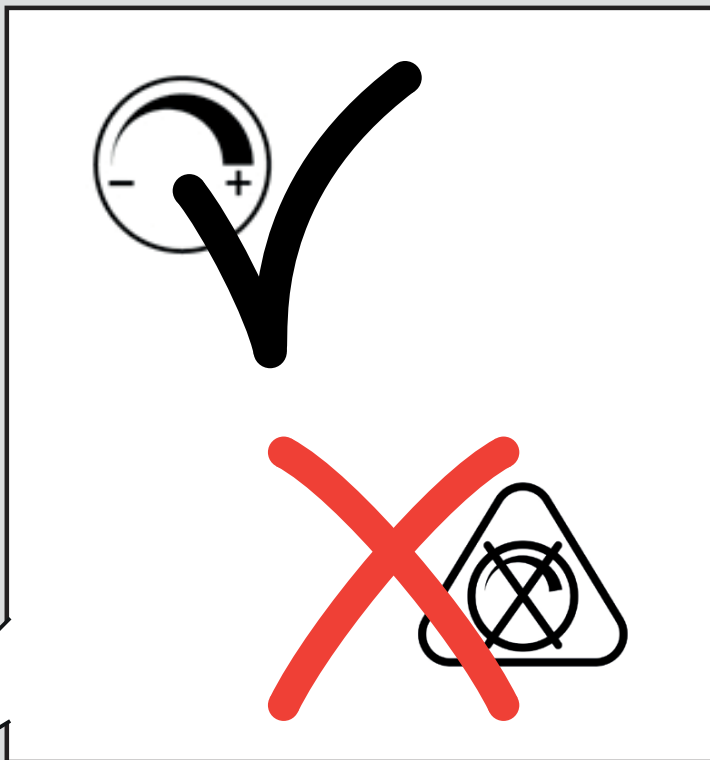
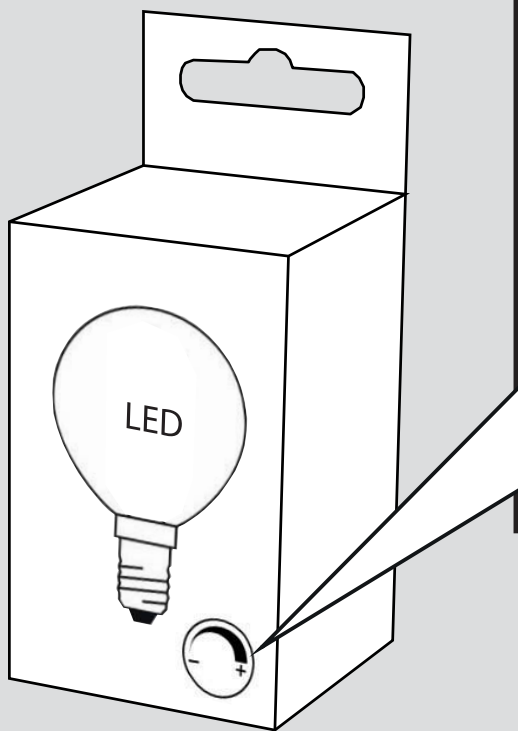

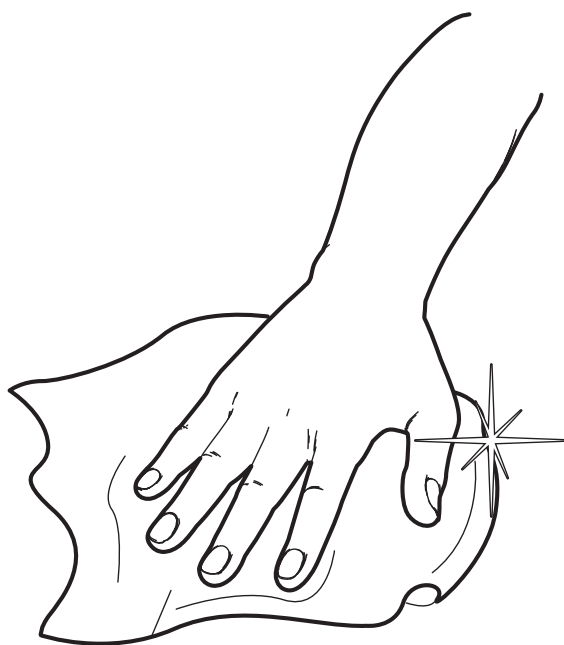
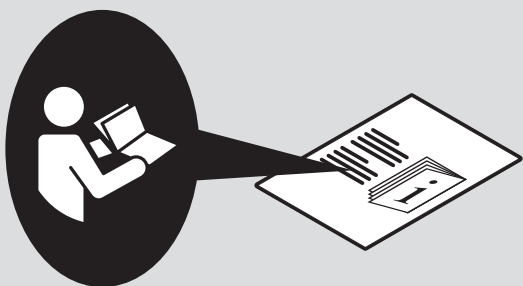

**Artemide®**



## **Artemide**

via Bergamo, 18  
20010 Pregnana M.se (MI)  
ITALIA

tel. +39 02 935 181  
fax +39 02 935 90 254  
fax +39 02 935 90 496

[www.artemide.com](http://www.artemide.com)

VAT IT00846890150

cod. Y513000652