



Catellani & Smith®

Lederam W

Ø 25 cm

wall or ceiling



ISTRUZIONI DI MONTAGGIO / ASSEMBLY INSTRUCTIONS / INSTRUCTIONS DE MONTAGE / MONTAGEANLEITUNGEN / INSTRUCCIONES DE MONTAJE

## I AVVERTENZE

- Togliere la tensione di alimentazione prima di effettuare l'installazione e per interventi di manutenzione o in caso di cattivo funzionamento.
- Si consiglia l'utilizzo dei guanti in dotazione. Per la pulizia della superficie utilizzare un piumino rimuovi-polvere.
- Non toccare lo schermo protettivo quando la lampada è accesa.
- Se il cavo di alimentazione esterno viene danneggiato, deve essere sostituito esclusivamente dal costruttore o dal suo servizio di assistenza.

## GB WARNINGS

- Switch off the power supply before installing, servicing or in case of malfunctioning.
- We suggest you to use the gloves provided. We recommend using a feather duster to clean the surfaces.
- Please do not touch the lamp's protective shield when the lamp is switched on.
- In case the supply cable of the lamp would be damaged, it has to be replaced exclusively by the manufacturer or by his technical service.

## F AVERTISSEMENTS

- Oter la tension d'alimentation avant d'effectuer l'installation, pour les interventions d'entretien ou en cas de fonctionnement défectueux.
- On conseille d'utiliser les gants fournis. Pour nettoyer la surface, nous vous conseillons d'employer un plumeau.
- Ne pas toucher l'écran protège-lampe lorsque la lampe est allumée.
- En cas de dommage au câble d'alimentation de la lampe, le remplacement doit être effectué par la société constructrice ou par son service.

## D WICHTIGE HINWEISE

- Schalten Sie vor der Installation, bei der Instandhaltung und bei schlechter Funktionsweise die Stromversorgung aus.
- Wir empfehlen, die mitgelieferte Handschuhe zu tragen. Es wird empfohlen, zur Reinigung der Oberfläche einen Staubwedel zu verwenden.
- Den Lampenschutzschirm nicht berühren, wenn die Lampe eingeschaltet ist.
- Im Falle einer Beschädigung des Netzkabels sollte die Reparatur nur durch den Hersteller/seinen Kundendienst durchgeführt werden.

## E ADVERTENCIAS



- Desconectar la tensión de alimentación antes de efectuar la instalación u operaciones de mantenimiento.
- Se aconseja usar los guantes suministrados. Para limpiar la superficie, se recomienda el uso de un plumero para el polvo.
- No toque la pantalla cuando la lámpara esté encendida.
- Si el cable eléctrico de esta lámpara está perjudicado, hay que hacerlo reemplazar por el fabricante u por sus servicio de asistencia técnica.

tensione di rete / voltage	lampadine / bulbs	trasformatore / transformer	dimmerazione / dimming
220V - 240V	1 x 17,5W modulo LED 230V	-	Triac / IGBT*
	1 x 17,5W LED module 230V	-	Triac / IGBT*
110V	1 x 17,5W modulo LED 110V	-	Triac / IGBT*
	1 x 17,5W LED module 110V	-	Triac / IGBT*

\* per informazioni/more info: [www.catellanismith.com/media/upload/pdf/pdf/Lederam-dimming.pdf](http://www.catellanismith.com/media/upload/pdf/pdf/Lederam-dimming.pdf)

### MODULO LED INTERCAMBIABILE / LED MODULE INTERCHANGEABLE



GRUPPO DI RISCHIO ESENTE IN ACCORDO ALLA NORMA EN 62471 / RISK EXEMPTION GROUP COMPLIANT WITH EN 62471		REGISTERED COMMUNITY MODEL	
I classe class	IP20 classe di protezione protection class	 persone suggerite per il montaggio people required for mounting	 MADE IN ITALY

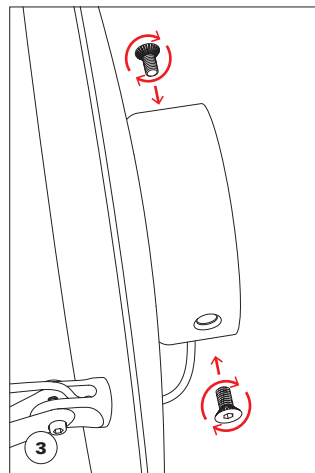
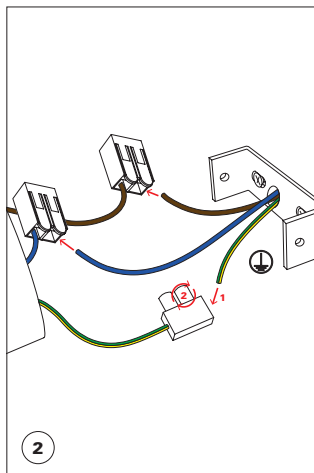
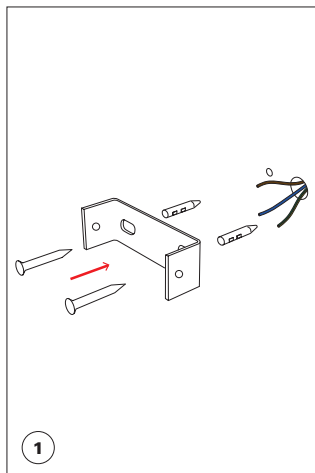

**ORIENTARE IL DISCO  
A LAMPADA SPENTA**

**ATTENZIONE!**

la posizione del disco di Lederam W25 può essere orientata SOLO allentando le viti di sicurezza A e B.

**ACT ON THE DISC  
WHEN THE LAMP IS SWITCHED OFF**

**WARNING!**

the position of the disc of Lederam W25 can be modified ONLY acting on the screws A and B.

Si possono scegliere 6 diverse posizioni di fissaggio. Per bloccare il disco nella posizione desiderata, re-inserire la vite nel foro, dopo averlo fatto combaciare con uno dei 6 fori interni dello snodo.

You can choose 6 different fastening positions. In order to fix the disc in the wished position, re-insert the screw in the hole, after matching it with one of the 6 inner holes on the joint.

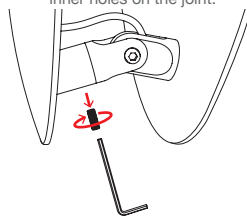

**A** Rotazione del disco / Disc rotation

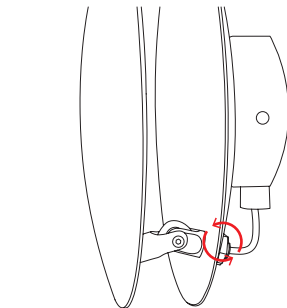

**B** Apertura del disco / Disc opening

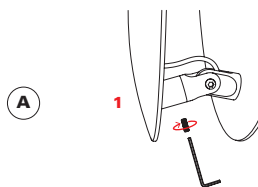

**A** 1 Allentare la vite  
Loosen the screw

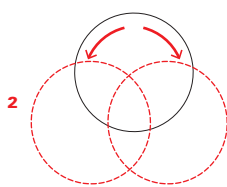

2 Orientare il disco a proprio piacimento  
Position the disc as wished

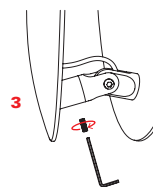

**A** 3 Stringere la vite  
Fasten the screw

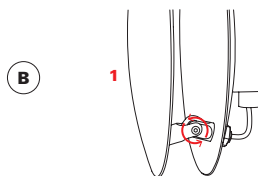

**B** 1

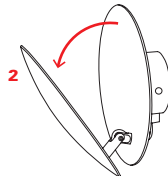

2

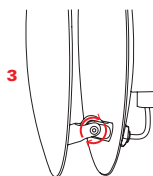

**B** 3



Questa apparecchiatura non deve essere smaltita come un normale rifiuto urbano, ma deve essere portata nel punto di raccolta appropriato per il riciclaggio di apparecchiature elettriche ed elettroniche. Provvedendo a smaltire questo prodotto in modo appropriato, si contribuisce ad evitare potenziali conseguenze negative per l'ambiente e per la salute umana, che potrebbero derivare da uno smaltimento inadeguato del prodotto. Per informazioni più dettagliate sul riciclaggio di questo prodotto, contattare l'ufficio comunale, il servizio locale di smaltimento rifiuti o il rivenditore presso il quale è stato acquistato il prodotto.

This equipment may not be treated as household waste. Instead it shall be handed over to the applicable collection point for the recycling of electrical and electronic equipment. By ensuring this product is disposed of correctly, you will help prevent potential negative consequences for the environment and human health, which could otherwise be caused by inappropriate waste handling of this product. For more detailed information about the recycling of this product, please contact your local city office, your household waste disposal or the dealer where you purchased this product.

Cet équipement ne doit être traité comme un déchet ménager. Il doit être remis à un organisme de collecte agréé pour le recyclage des équipements électriques et électroniques. En vous assurant que ce produit est correctement traité, vous éviterez de potentiels effets négatifs sur l'environnement et la santé humaine qui autrement pourraient être causés par un recyclage inapproprié de ce produit. Pour avoir des informations plus détaillées concernant le recyclage de ce produit, prenez contact avec votre Mairie ou votre organisme de collecte des déchets ménagers ou bien avec la société qui vous a vendu ce produit.

Das Gerät soll nicht als normaler Hausmüll entsorgt, sondern in Recycling Sammelstellen für elektrische und elektronische Geräten abgegeben werden. Wenn dieses Produkt korrekt entsorgt wird, dann können die aus einem falschen Entsorgungsverfahren entstehenden potentiellen negativen Auswirkungen auf die Umwelt als auch auf die menschliche Gesundheit vermieden werden. Für nähere Informationen über die Beseitigung von diesem Produkt, bitte kontaktieren Sie Ihr Stadtamt, Ihr lokales Entsorgungsservice oder den Hersteller, der Ihnen das Produkt verkauft hat.

Este equipo no debe desecharse como si de residuos caseros se tratara. Deberá llevarse al punto de recogida de equipo eléctrico y electrónico que proceda para su reciclaje. Deshaciéndose correctamente de este producto, usted ayudará a prevenir potenciales consecuencias negativas para el medioambiente y posibles daños a la salud pública, que de otro modo se podrían producir en caso de manejar de modo impropio o negligente este tipo de residuos. Para obtener información más detallada acerca del reciclaje de este producto, por favor contacte con las autoridades locales, alguna compañía especializada en la materia o con el distribuidor de este producto.

