

## Sento terra datasheet

LED floor luminaire, connection via power supply unit (converter) with wall plug. Modular LED head-body-system allows free combination of different surfaces of head, body and base. Removable head for configuration and maintenance purposes, LED changeable. Heads available with one sided or double sided light output, power of light source 18W or 26W.

Lighting effect changeable by using optional inserts, dichroic color filters can be added. Adjustment via heat-decoupled carbon pin (fixation of head against rotation optional). Switch- and dimmable via controller operated by foot or via »touchless control« with gestures at the head.

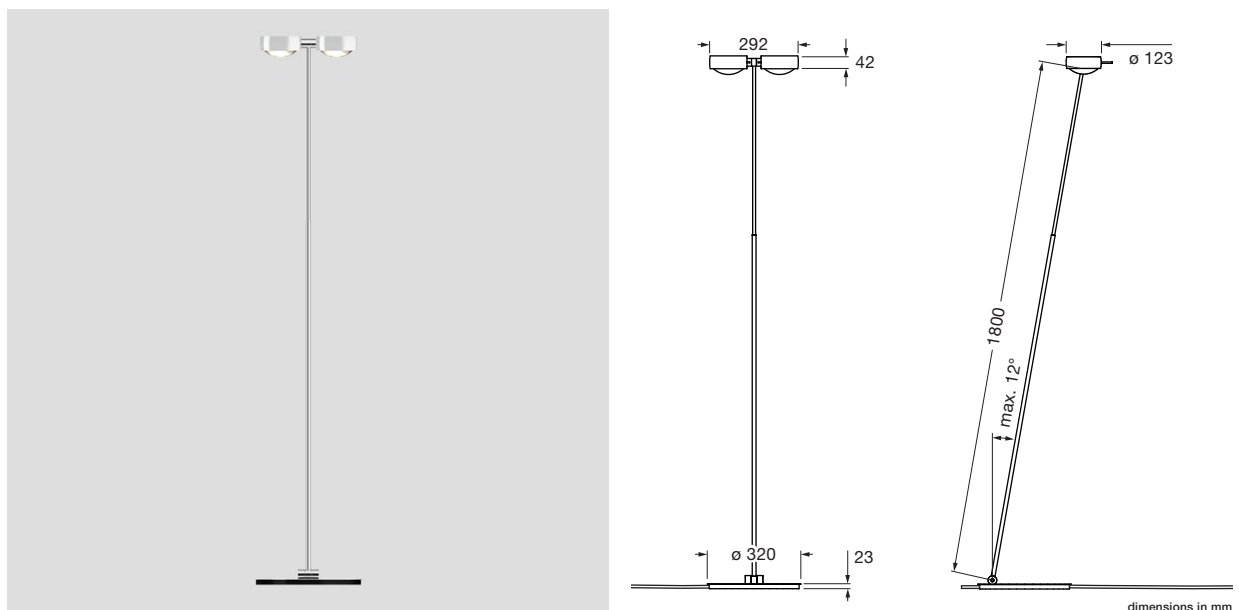

### technical data Sento terra

properties	material	aluminium, steel chrome-plated, painted or anodised, plastic, glass, optical plastic	
	length	1800 mm	
	rotation head	360°	
	swivel range	max. 12°	
	weight	13.6 kg	
surface	head	matt gold, rose gold, bronze, shiny chrome, matt chrome, glossy white, matt white, matt black, phantom, black phantom	
	body	matt white, matt black, shiny chrome, matt chrome	
	base	shiny chrome, glossy white, matt chrome, matt white, matt black	
	cable	matt black, transparent	
Occhio LED	average life time	> 50.000 hrs	
	energy efficiency class	G	
	power	26 W / 18 W	
	color rendering index	perfect color; CRI Ra 97	high flux; CRI Ra 85
	color temperature	2700, 3000 K	3000, 3500, 4000 K
recommended use	residential and public	public	
electricity	dimming	»touchless control« and Occhio air (optional) or controller	
	power supply unit	controller with integrated converter, cable length 180 cm, for use with 230 V AC	
	permitted operating conditions	max. 30°C for indoor use only	



## Sento terra lighting effects

 head single sided

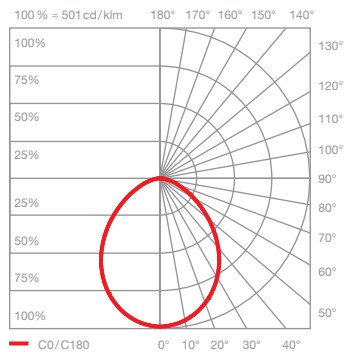
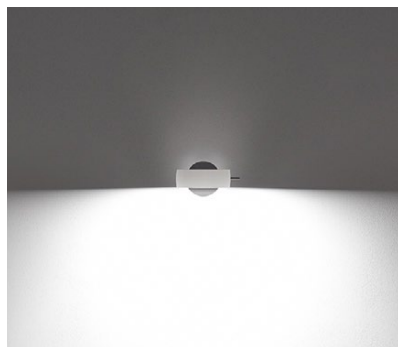

### Sento B

diffuse light

insert: diffusor glass

luminous flux:	perfect color	26 W	1370lm
	high flux	26 W	1870lm
	perfect color	18 W	1000lm
	high flux	18 W	1370lm

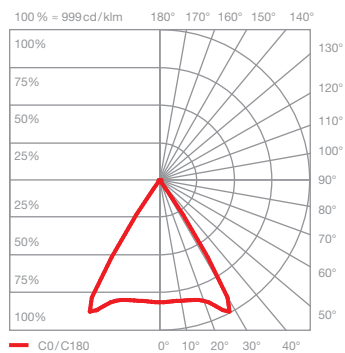

### Sento C

directed light  
beam angle approx. 80°

insert: lens

luminous flux:	perfect color	26 W	1570lm
	high flux	26 W	2150lm
	perfect color	18 W	1140lm
	high flux	18 W	1570lm

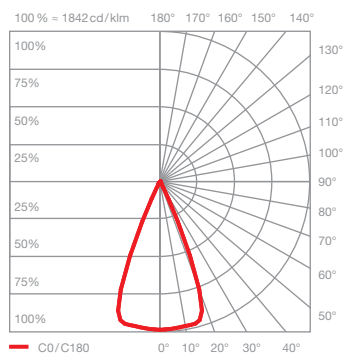
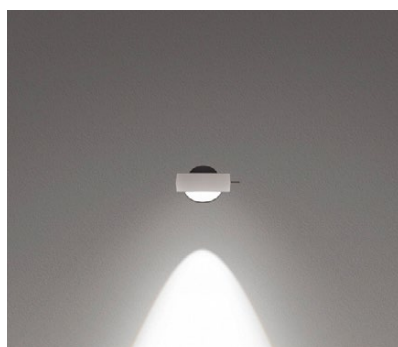

### Sento S40

directed light  
beam angle approx. 40°

insert: spot lens, lens  
soft edge glass

luminous flux:	perfect color	26 W	1560lm
	high flux	26 W	2130lm
	perfect color	18 W	1130lm
	high flux	18 W	1560lm

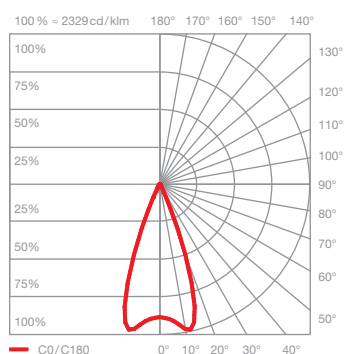
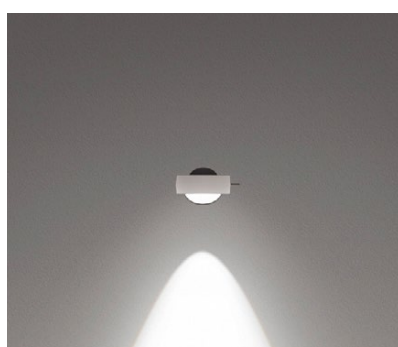

### Sento S30

directed light  
beam angle approx. 30°

insert: spot lens, lens  
fresnel lens

luminous flux:	perfect color	26 W	1530lm
	high flux	26 W	2080lm
	perfect color	18 W	1110lm
	high flux	18 W	1530lm

## Sento terra lighting effects

 head double sided

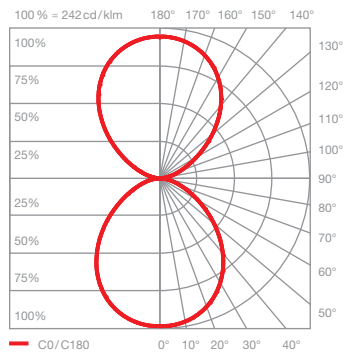
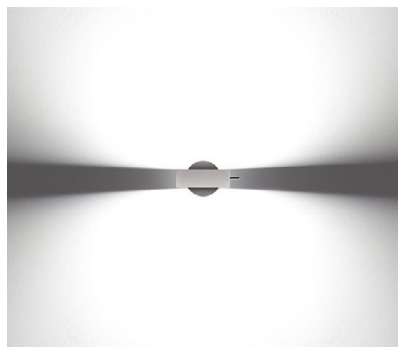

### Sento A

diffuse light in both directions

insert: diffuser glass  
diffuser glass

luminous flux: perfect color 26 W 1500lm  
high flux 26 W 2040lm

perfect color 18 W 1090lm  
high flux 18 W 1500lm

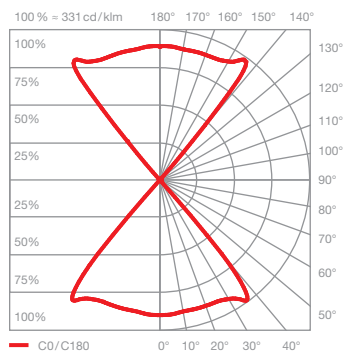

### Sento D

directed light in both directions  
beam angle approx. 80°

insert: lens  
lens

luminous flux: perfect color 26 W 1750lm  
high flux 26 W 2390lm

perfect color 18 W 1270lm  
high flux 18 W 1750lm

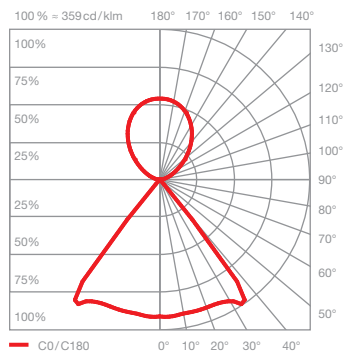
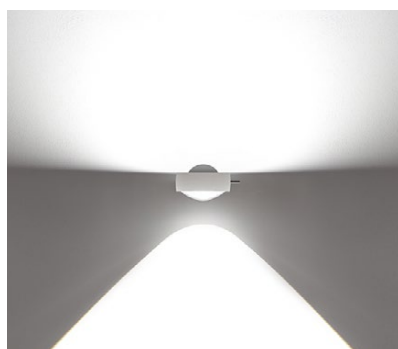

### Sento E

diffuse up light  
directed down light  
beam angle approx. 80°

insert: diffuser glass  
lens

luminous flux: perfect color 26 W 1620lm  
high flux 26 W 2200lm

perfect color 18 W 1170lm  
high flux 18 W 1620lm