

## technics

In case of precast concrete panels, gear inclusive.

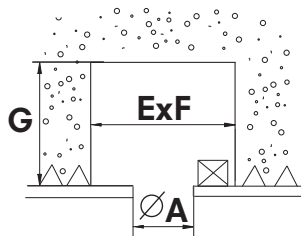

In case of finished concrete ceiling, gear exclusive.

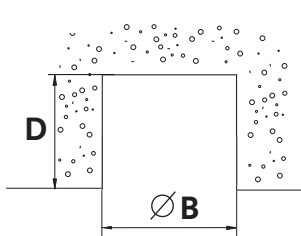

Name	Reference	Lamptype	∅A	E	F	G	∅B	D
Concrete plasterkit aplis IL 80 (shadow gap)	KR717101 (9)	QR-CBC51	140	320	320	200	170	130
(small)	(2)	LED dir (Kr91773x)	140	300	300	157	170	140
(shadow gap - small)	(7)	LED dir (Kr91793x)	140	344	344	120	390	115
		LED fixed, WW (KR91733x, Kr91703x)	140	260	260	100	250	100
		Audio	140	200	200	130	150	130
		Diapason 40/80/120 base LED	140	260	260	70**	110	70
		Holon 80 directional LED	140	260	260	X**	110	60
		ATO in-line 80	140	300	300	157	170	140
Concrete plasterkit aplis IL 120 (shadow gap)	KR707201 (9)	LED dir., fixed, wallwasher	140	350	350	150	305	200
		LED low	140	390	390	150	305	237
Concrete plasterkit aplis IL 165 (shadow gap)	KR717201 (9)	QT12-ax	200	200	450	200	210	195
		QR-LP111	200	200	450	230	210	178
		HIT_TC	200	200	450	230	210	225
		HIR-CE111	200	200	450	230	210	203
		LED dir.	200	280	450	230	210	230

## 1 cut out

\*\* Mind that the driver dimensions WxH cannot exceed 67x29,5mm!  
the length of the driver determines G as it has to be pushed perpendicular through the plasterkit. Depth = length of the driver + 30mm  
(in case of Holon 80 when the standard drivers KR77223x G = 130mm)

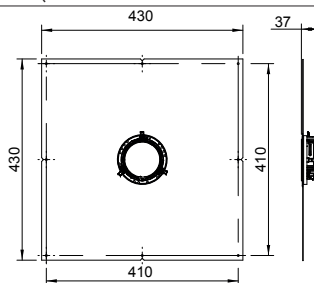

Aplis in-line 80

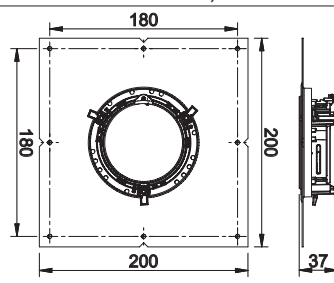

Aplis in-line 80 (small concr. Plasterkit)

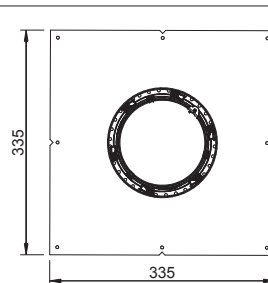

Aplis in-line 120

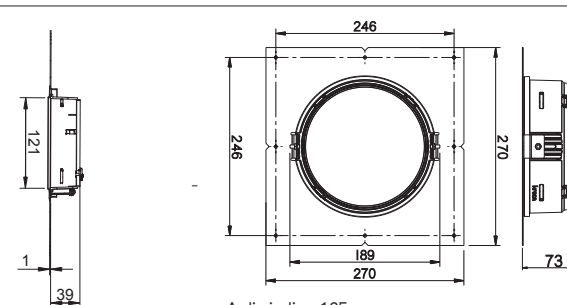

Aplis in-line 165

## 2 dimensions

Reinforce perfo plate with gypsum plate or wooden plate to avoid bending.

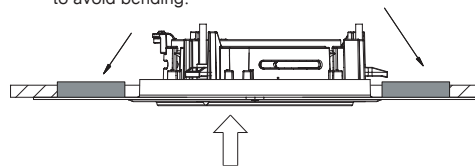

Put the plasterkit through the hole.

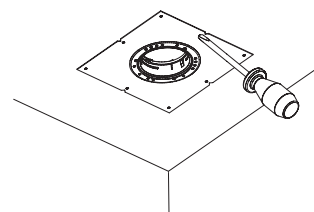

Fix the plasterkit with screws.

In case of aplis IL 165.

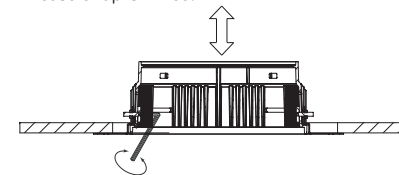

Align the box with the plasterboard using the thumb screw. Fix these screws with a hexagon screw key.

## 3 installation

In case of 80 range please make sure that sticker is removed before proceeding!

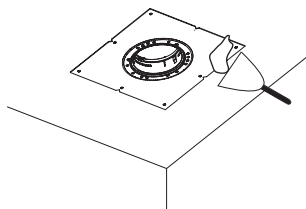

Fill around perimeter of plasterkit using suitable filler and plaster to hide screws and plasterkit.

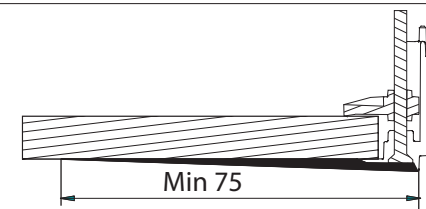

Minimum filler distance, spread out until zero.

## 4 installation

kreon nv

Industrieweg Noord 1152  
3660 Opglabbeek  
Belgium

Tel + 32 89 81 97 80  
Fax + 32 89 81 97 90

www.kreon.com  
mailbox@kreon.be

revision date: 24/05 /2018  
KR8170001800