

629

**COBRA**

Elio Martinelli – 1968

**martinelli luce**



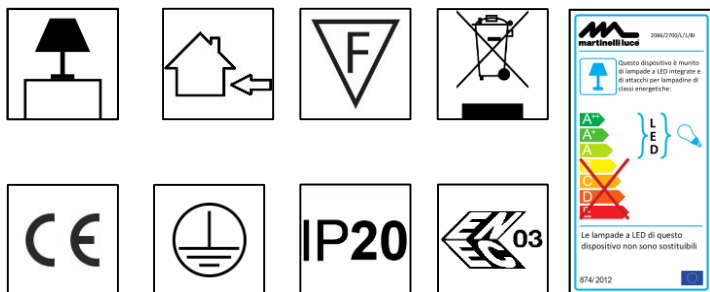

x 1

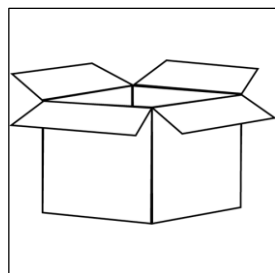

x 1

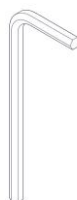

x 1

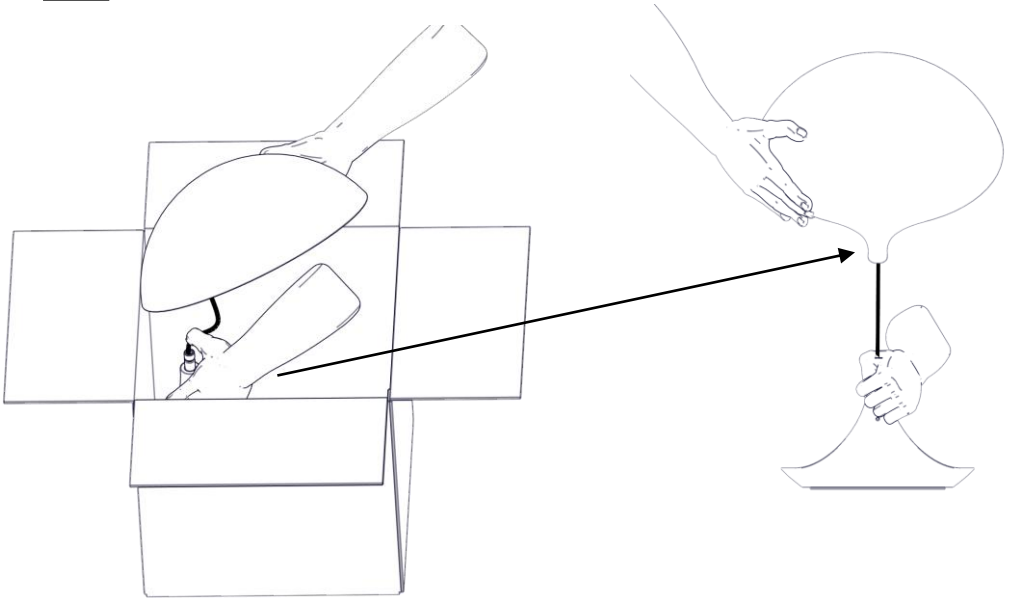
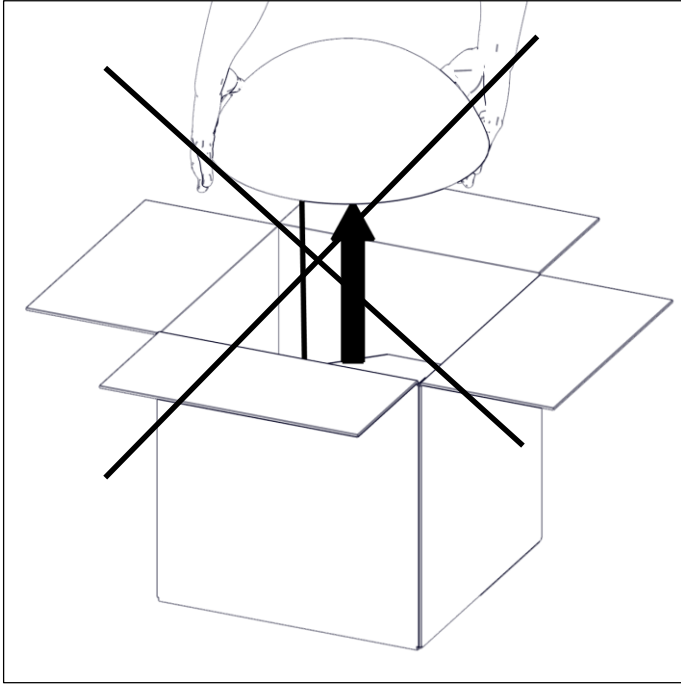

1

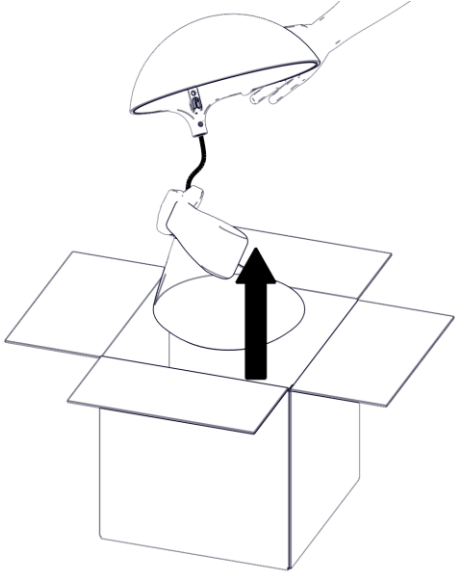

2

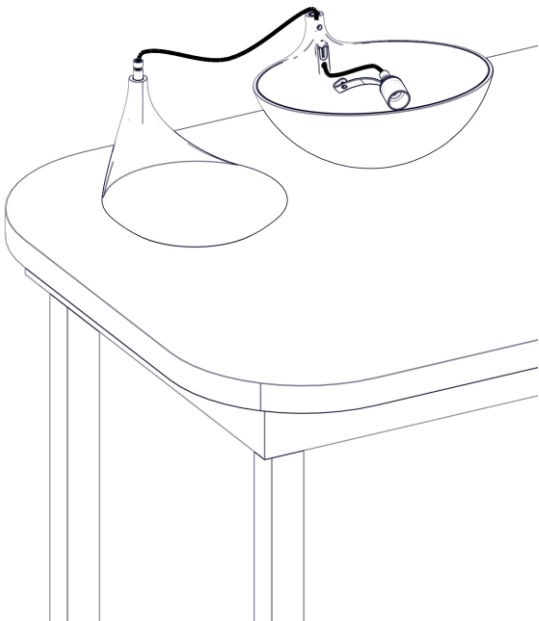

3

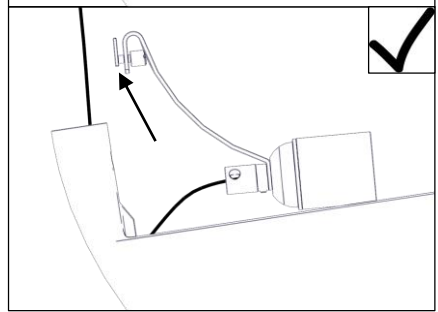
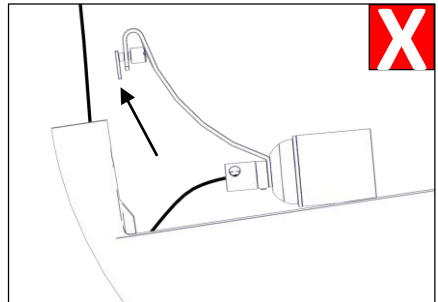
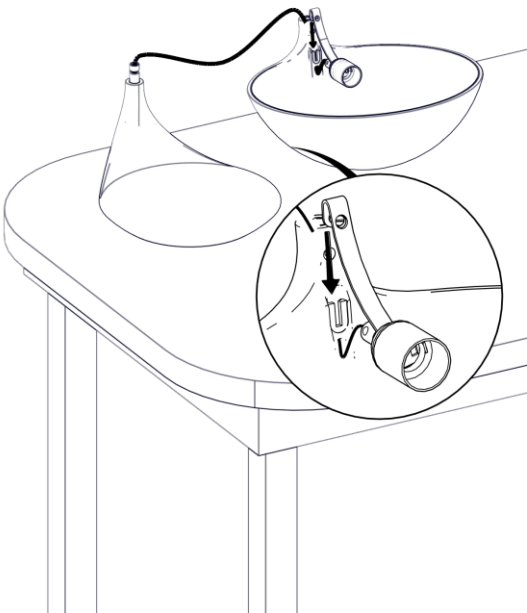

4

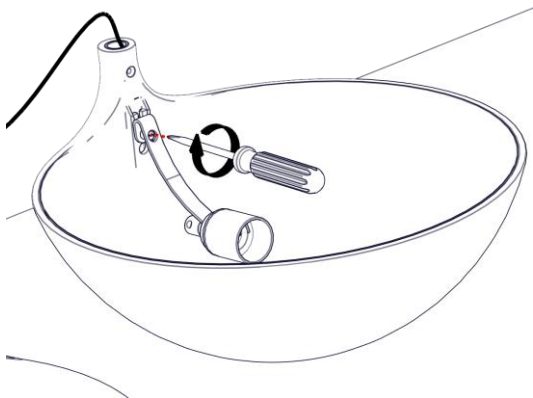

5



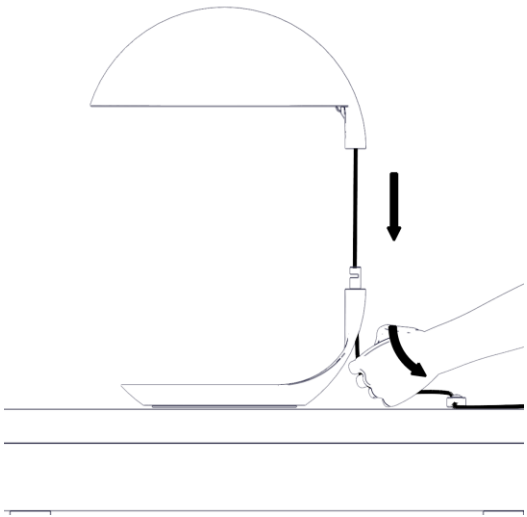

6

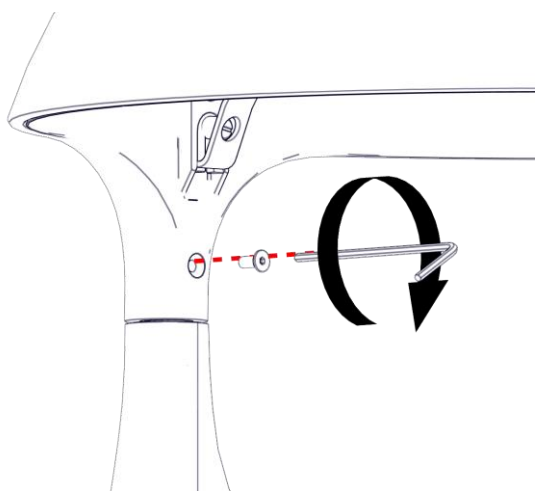

7

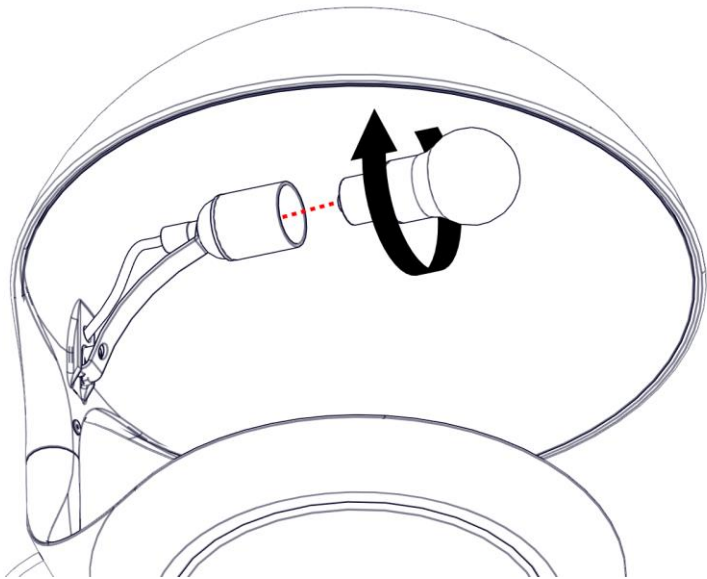



 9 W LED E27

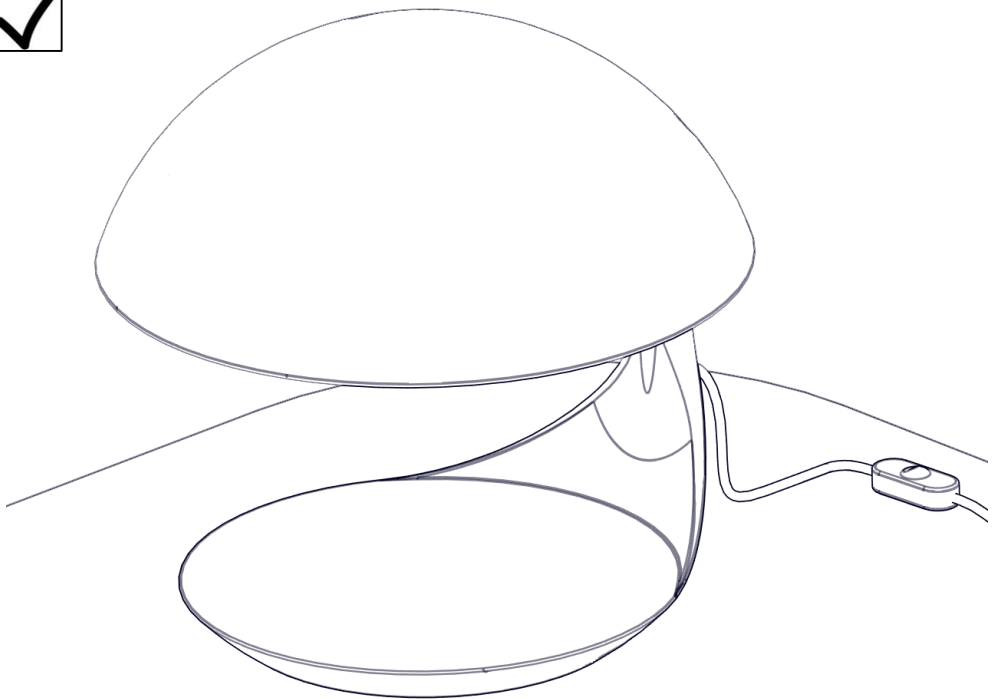

*i*

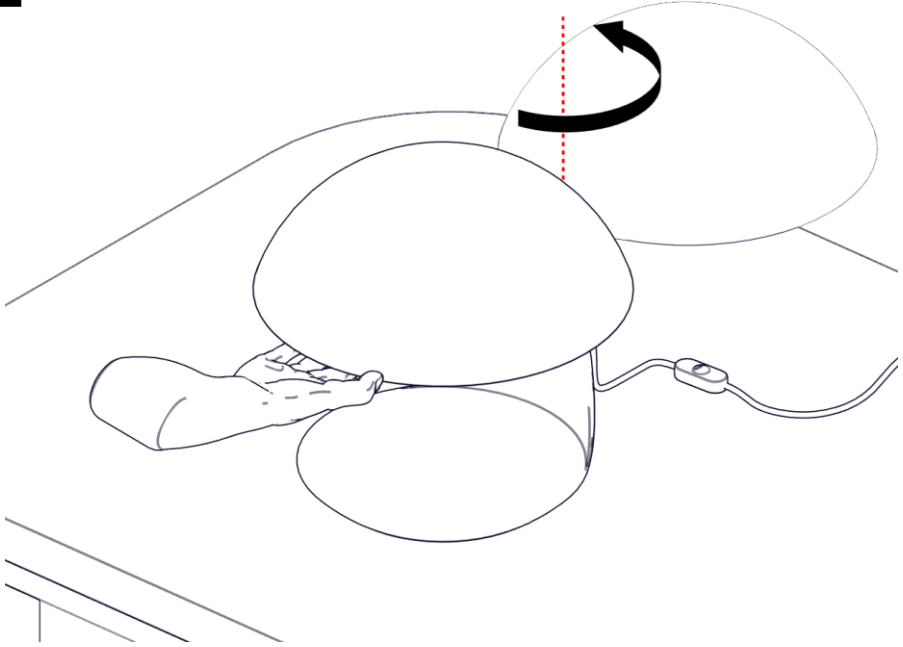

*i*

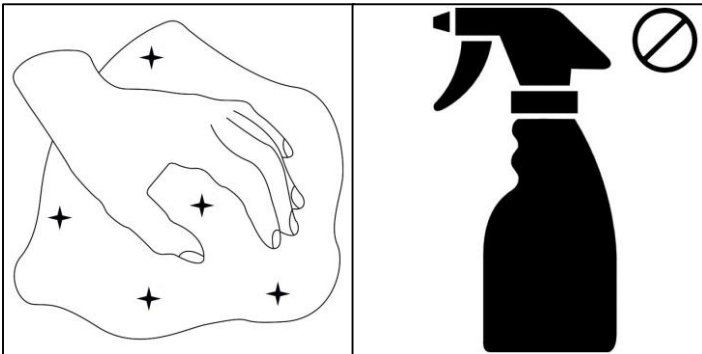

# **martinelli luce**

Via Teresa Bandettini  
55100 Lucca (Lu) – Italy

Tel.+39/0583.418315  
Fax. +39/0583.419003

[www.martinelliluce.it](http://www.martinelliluce.it)  
[info@martinelliluce.it](mailto:info@martinelliluce.it)