

## Mito volo 100 fix up midfeed datasheet

Linear LED suspended luminaire with double-sided light emission, centered ceiling outlet and length of 103 cm. There is a choice of two lighting effects. table (wide) for use over tables – wide light beam directed downwards and upwards. room (narrow) for freely suspended luminaire lighting – concentrated light beam directed downwards, diffused light directed upwards. The suspension length is 50–350 cm (can be adjusted during fitting).

Version with integrated power supply unit for mounting on plaster surfaces; connection to 230 V AC mains voltage. Can be controlled via »touchless control« (gesture control on the head) and Occhio air or DALI; alternatively, dimmable via a trailing-edge phase cut dimmer\*. The colour temperature can be continuously controlled via »touchless control« or Occhio air or DALI from 2700 to 4000 K or can be preset (2700/3000/3500/4000 K).

Other version: Mito alto flat (40/70/100), Mito alto up (40/70/100), Mito alto side (40/70/100), Mito volo fix flat (100/140), Mito volo var up (100/140), Mito volo fix up (100/140), Mito volo fix up midfeed (140)

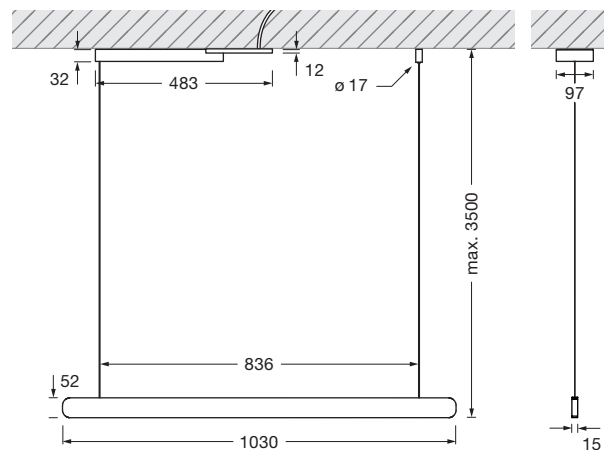

incl. power supply unit

dimensions in mm

### technical data Mito volo 100 fix up midfeed

properties	material	<b>head</b> aluminium, painted, anodised or PVD-coated steel, optical plastic <b>canopy</b> painted plastic
	height setting	500–3500 mm (can be adjusted during fitting)
	weight	2.9 kg
surface	head	bronze, matt gold, rose gold, matt silver, matt white, matt black
	canopy	matt white, matt black
Occhio »color tune« LED	average life time	> 50.000 hrs
	energy efficiency class	A+
	power	45 W (incl. Occhio power supply unit approx. 52 W)
	color rendering index	high color; CRI Ra 95
	color temperature	2700–4000 K
	recommended use	residential, commercial, office
electricity	dimming	via trailing-edge phasecut dimmer*, »touchless control«, Occhio air or DALI
	connection	230 V AC / 50 Hz
	permitted operating conditions	max. 30°C for indoor use only

\* For a list of compatible dimmers, see [www.occhio.de/dim\\_en](http://www.occhio.de/dim_en), trailing-edge phasecut dimmer, »touchless control«, Occhio air and DALI not combinable Anodised (matt gold) and PVD surfaces (rose gold, bronze) may differ slightly from other product lines.



## Mito volo 100 fix up midfeed lighting effects

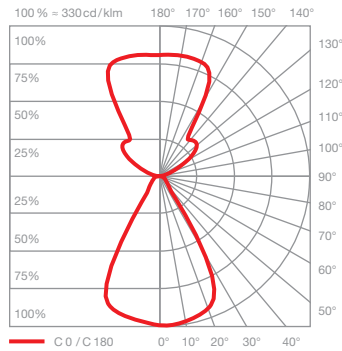

### table (wide)

wide light beam (up and down), beam angle approx. 80° (down)

inserts: wide / flood

luminous flux: high color 45 W 2900lm

UGR (4H8H) < 19 \*

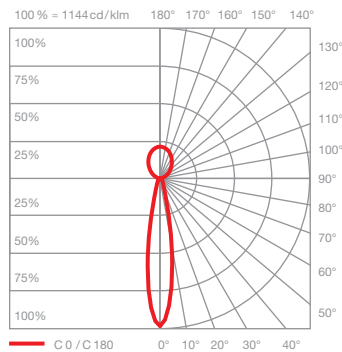
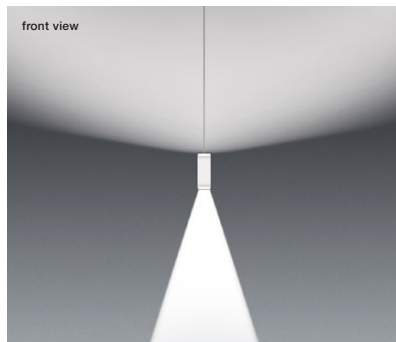
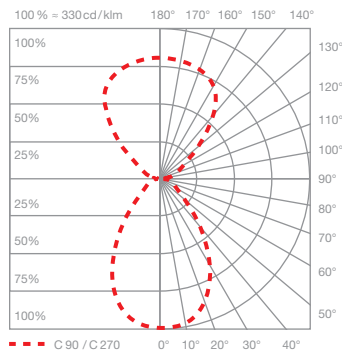

### room (narrow)

concentrated light downwards, beam angle approx. 25°, diffuse upwards

inserts: narrow / diffuse

luminous flux: high color 45 W 2600lm

UGR (4H8H) < 19 \*

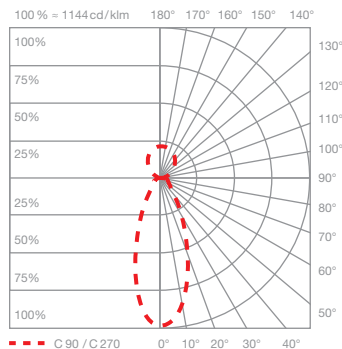
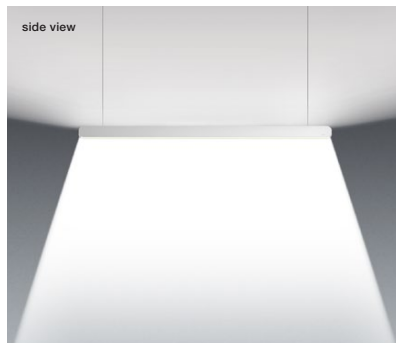

\* For a reliable assessment of glare values in a real application of a luminaire we recommend to carry out an individual calculation which can be prepared by our lighting team (project-support@occhio.de).

## Mito volo 100 fix up midfeed connection diagram

A maximum of 32 Mito volo units can be assigned to each DALI circuit.

The Mito volo requires two DALI addresses per luminaire, which enables control of the top and bottom sides via their own respective DALI address. The maximum output is reached if both DALI luminaires (top and bottom side) are set to maximum brightness (45 W = 22 W up and 22 W down; 60 W = 30 W up and 30 W down).

The Mito volo units can be organized into as many as 16 groups and equipped with an additional 16 scenarios (predefined settings).

Using a DALI short address, they can be actuated and configured individually. In addition, the bi-directional data transfer lets users query the state/status of individual luminaires.

You can find more detailed information at [www.occhio.de/dali](http://www.occhio.de/dali).

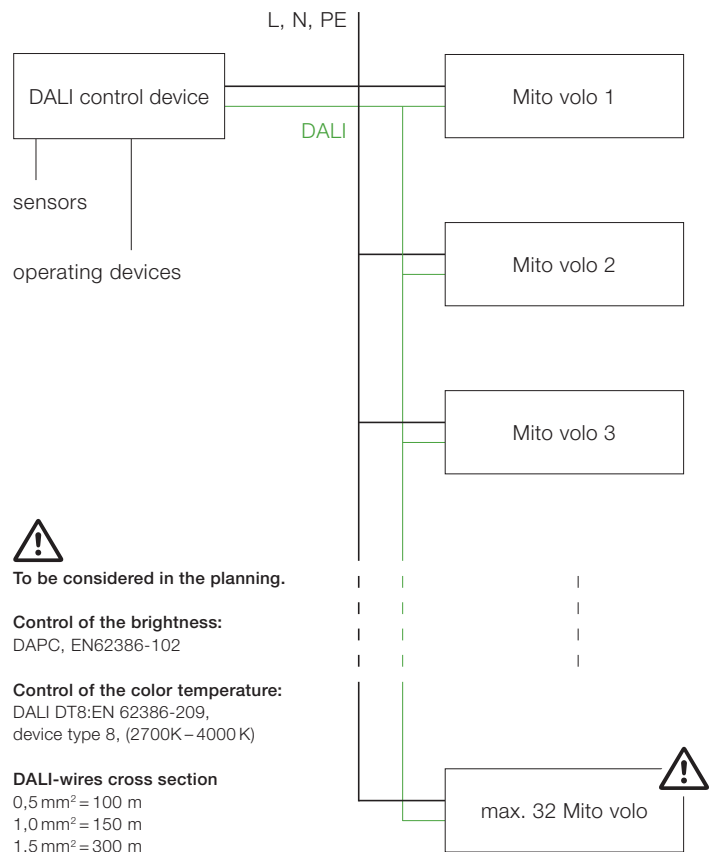

## control options

### control

#### Mito set box (standard)



sospeso / volo

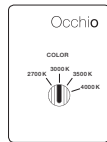

soffitto / alto flat



alto up & side

#### sospeso / volo:

COLOR (Sensor off)  
adjustable color temperature (4 steps)  
trailing-edge phase cut dimming possible

#### STEP

adjustable color temperature (4 steps)  
adjustable up / downlight ratio (5 steps)  
trailing-edge phase cut dimming possible

#### SENSOR

»touchless control« (gesture control)  
switching, dimming, up / down fading  
color tune (color temperature continuously adjustable)  
no external dimming possible

#### soffitto / alto flat / alto up & side:

COLOR  
adjustable color temperature (4 steps)  
trailing-edge phase cut dimming possible

#### Mito »air« box (optional)



sospeso / volo



alto up & side



**Occhio air** (Bluetooth control using Occhio air app) or air controller (optional)  
control of individual luminaires, groups and scenes

#### sospeso / volo:

SENSOR  
»air« + »touchless control« (Bluetooth- und gesture control)  
control via »touchless control« and Occhio air app or air controller

#### SENSOR OFF

»air«  
control via Occhio air App or air controller  
switching, dimming, up / down fading  
color tune (color temperature continuously adjustable)



terra / terra 3d /  
soffitto / alto flat

#### terra / terra 3d:

»air«, »touchless control« and »body sensor«  
(Bluetooth- und gesture control)  
control via »touchless control«, »body sensor«  
and Occhio air App or »air« controller

»ambient light control«  
adjustment to ambient light

»presence sensor«  
presence identification and automatically  
shutdown by presence sensor

deactivation and adjustable via control  
and sensor with air app

#### soffitto / alto flat / alto up & side:

»air« (Bluetooth - control)  
control via Occhio air App or »air« controller  
switching, dimming  
color tune (color temperature continuously adjustable)

**Occhio air  
powered by  
Casambi**

with Mito air box no external dimming possible

#### Mito DALI box (optional)



sospeso / volo /  
soffitto / alto flat



alto up & side

#### control via DALI

##### sospeso / volo / soffitto / alto flat

- color tune adjustable\*\*
- adjust continuously dimming
- up + downlight separate controllable (two DALI addresses needed)
- no »touchless control«, no fading
- volo 100 (max. 22,5 W uplight / 22,5 W downlight)
- volo 140 (max. 30 W uplight / max. 30 W downlight)

##### alto up & side

- color tune adjustable\*\*
- continuously dimming

\*\* DALI controller DALI Device type 8 (DT8) for controlling of the color tune necessary  
further signs on [www.occhio.de/dali](http://www.occhio.de/dali)